

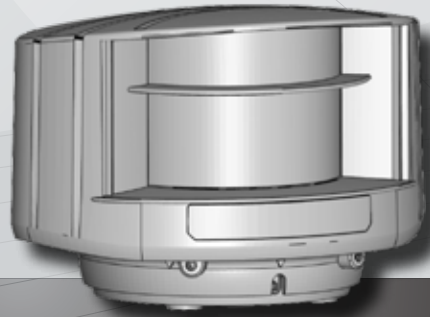

EN



LZR[®]-H110

LASER SCANNER FOR BARRIERS & GATES
with max. detection range of 5.0 m x 6.5 m
(16.5 ft x 21 ft)

User's Guide

SAFETY



The device contains IR and visible laser diodes.
IR laser: wavelength 905nm; max. output pulse power 75W (Class 1 according to IEC 60825-1)
Visible laser: wavelength 650nm; max. output CW power 3mW (Class 3R according to IEC 60825-1)

The visible laser beams are inactive during normal functioning.
The installer can activate the visible lasers if needed.



CAUTION!

Use of controls, adjustments, or performance of procedures other than those specified herein may result in hazardous radiation exposure.

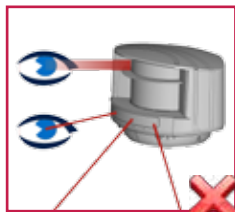

Do not look into the laser emitter or the visible red laser beams.



The warranty is void if unauthorized repairs are made or attempted by unauthorized personnel.



Only trained and qualified personnel are recommended to install and set up the sensor.

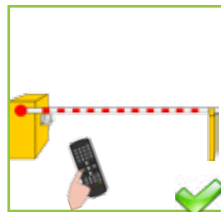

After installation, enter an access code by remote control.



This sensor is designed to be used as a movement and presence detector to initiate the opening and the closing process of a gate or a barrier. Other use of the device, especially on industrial doors, is outside the permitted purpose and cannot be guaranteed by the manufacturer and might infringe the following patent application EP 1 470 314 B1. The manufacturer of the system is responsible for installing the sensor and the system in compliance with applicable national and international regulations and standards on safety and if applicable, the machinery directive 2006/42/EC. The manufacturer of the sensor cannot be held responsible for incorrect installations or inappropriate adjustments of the sensor.

INSTALLATION AND MAINTENANCE



Avoid extreme vibrations.

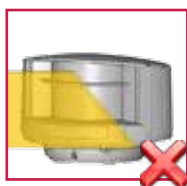

Do not cover the front screens.



Avoid moving objects and light sources in the detection field.



Avoid the presence of smoke and fog in the detection field.



Avoid condensation.

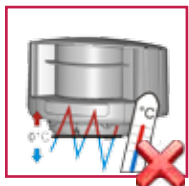

Avoid exposure to sudden and extreme temperature changes.



Avoid direct exposure to high pressure cleaning.



Do not use aggressive products to clean the front screens.



Wipe the front screens regularly with a clean and damp cloth.



Keep the sensor permanently powered in environments where the temperature can descend below 0°C.

DESCRIPTION

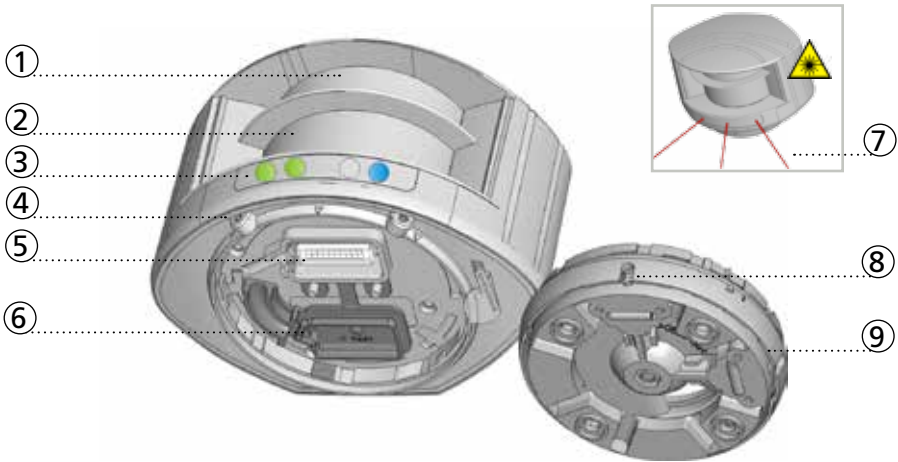

- | | |
|--------------------------------|--|
| 1. laser sweep emission | 6. protection cover |
| 2. laser sweep reception | 7. visible laser beam (3) |
| 3. LED signal (4) | 8. notch for tilt angle adjustment (2) |
| 4. screw for position lock (2) | 9. adjustable bracket |
| 5. connector | |

LED SIGNAL

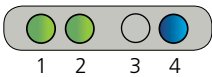

1. Detection LED: relay 1 – opening field
2. Detection LED: relay 2 – safety field
3. Error LED
4. Power LED



LED flashes quickly



LED flashes



LED flashes slowly



LED is off

DETECTION LEDs

- | | |
|--|--------------|
| | detection |
| | no detection |

ERROR LED

- | | |
|--|----------|
| | error |
| | no error |

POWER LED

- | | |
|--|----------|
| | power |
| | no power |



All 4 LEDs can be switched off and on again by remote control. This can be useful in cases where the sensor should not draw any attention.



SYMBOLS



Caution!
Laser radiation



Remote control
sequence



Possible remote control
adjustments



Factory values



Important



Tip



Quick
installation

HOW TO USE THE REMOTE CONTROL



After unlocking, the first LED flashes red and the sensor can be adjusted by remote control.



If the red LED flashes quickly after unlocking, you need to enter an access code from 1 to 4 digits.



To end an adjustment session, always lock the sensor.

ADJUSTING ONE OR MORE PARAMETERS

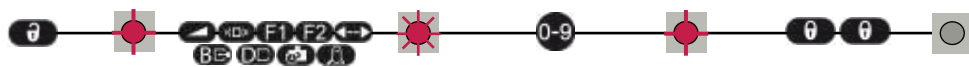

CHECKING A VALUE

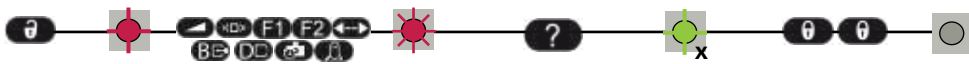

= field width: 4.2 m
 = field width is defined by teach-in

RESTORING TO FACTORY VALUES

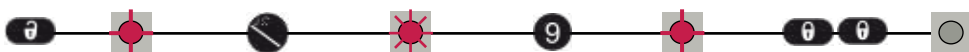

SAVING AN ACCESS CODE

The access code is recommended for sensors installed close to each other.

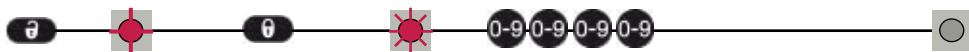

DELETING AN ACCESS CODE

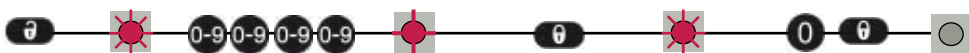

Enter the existing code



X = NUMBER OF FLASHES = VALUE OF THE PARAMETER

1 MOUNTING

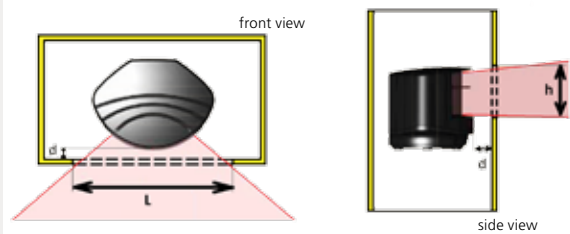

d (mm) distance between laser and opening	l_{min} (mm)	h_{min} (mm)
50	240	52
100	360	59
150	480	66
200	600	73

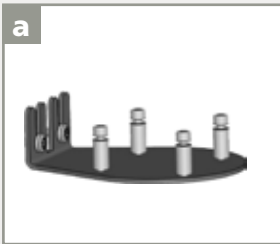

Use the LBA mounting support for installation on the pole.



Position the bracket and secure using the 4 screws to avoid vibrations.



Open the protection cover, plug the connector and position the cable in the slit.



Close the protection cover and secure it.

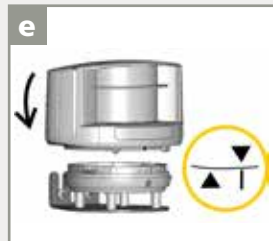

Position the housing on the bracket.



Rotate the sensor until the two triangles are face to face.

2 WIRING

RED		POWER SUPPLY +	Power on with test
BLACK		POWER SUPPLY -	
WHITE		RELAY 1 - OPENING FIELD	No detection
GREEN			Detection on both relays
WHITE/BLACK		RELAY 2 - SAFETY FIELD	 <i>The sensor tests both relays.</i>
GREEN/WHITE			
BLUE		TEST +	
BLUE/WHITE		TEST -	
ORANGE		NOT USED	
ORANGE/BLACK		NOT USED	

No test function: connect blue and blue/white wires to power supply (no polarity)

3 POSITIONING (3 SPOTS)

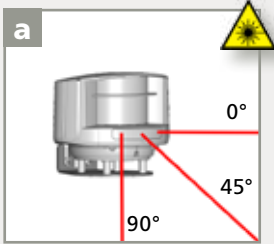

Activate the visible laser beams by remote control. To turn off, use same sequence. After 15 minutes, the beams switch off.

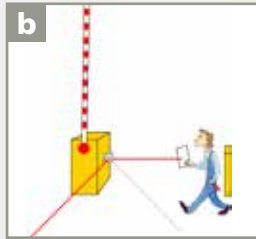

Verify the lateral position of the sensor. Make sure the laser beam is visible on the opposite pole.

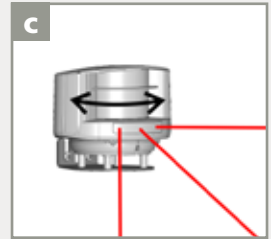

If not, turn the sensor slightly on its axis to find the correct position.

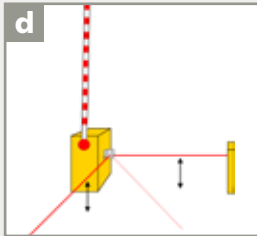

Verify if both beams are on equal height.

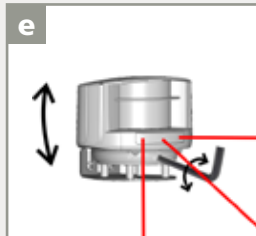

Adjust the tilt angle of the detection field with the hex key.



Lock the position of the mounting bracket to avoid malfunctioning in case of extreme vibrations.

4 MOUNTING SIDE

Choose the correct mounting side: **LEFT** or **RIGHT**



1

left

2

right

3

left

4

right

WITH REFERENCE POINT (surface of min. 15 cm)

The sensor will automatically adjust the safety field on the basis of the reference point if C = 00.

WITHOUT REFERENCE POINT

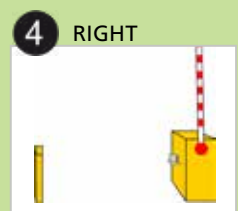
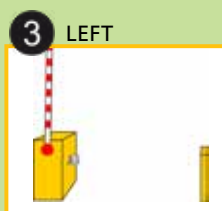
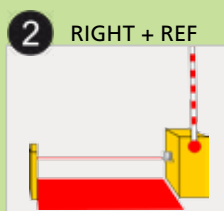
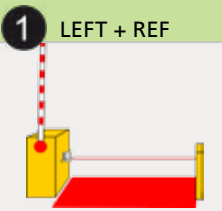

5 SAFETY FIELD – PRESENCE

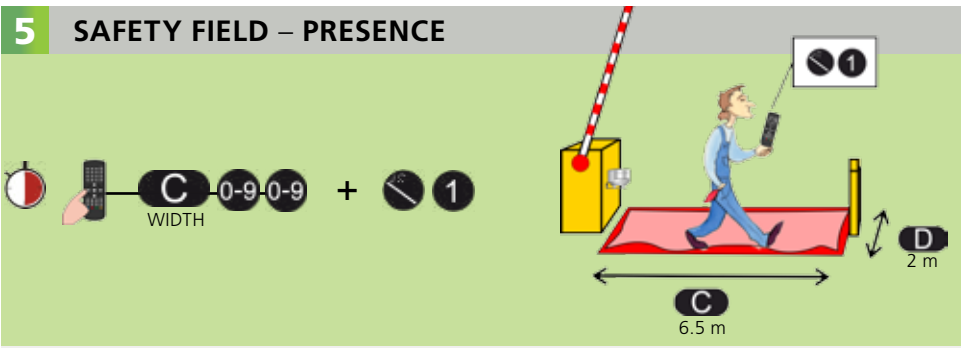

TEACH-IN

The safety field can be adapted more precisely by launching a teach-in (the sensor learns the environment). Before launching a teach-in, make sure that the selected field size is bigger than the desired field size.



The detection field should be free of snow buildups, heavy rain, snowfall, fog, or other moving objects.

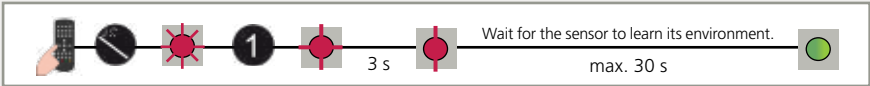

During the teach-in (30 sec.), the sensor records the reference distances to all objects within its detection zone.

If you walk along the detection area while the teach-in function is active, the sensor memorizes the outline of the walk path and stores this as a new detection field. The shortest distance measured by each laser beam is stored by the sensor and determines the field limit.

Once the sensor has finished the teach-in, make sure that the safety field is correctly configured and that the area around the barrier or gate is safe.

You can increase or decrease the field by 10 cm:



FIELD DIMENSIONS

Adjust the field dimensions if you want to get a rectangular field.

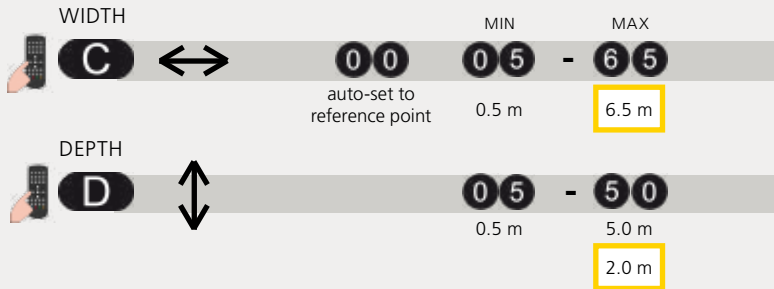

EX: for a field width of 6.2 m



The safety field is necessary for the correct functioning of the installation. If the safety field is too small, the manufacturer of the sensor cannot be held responsible for inappropriate functioning of the installation.



Always launch a new teach-in after adjusting the field dimensions.

6 OPENING FIELD – MOTION

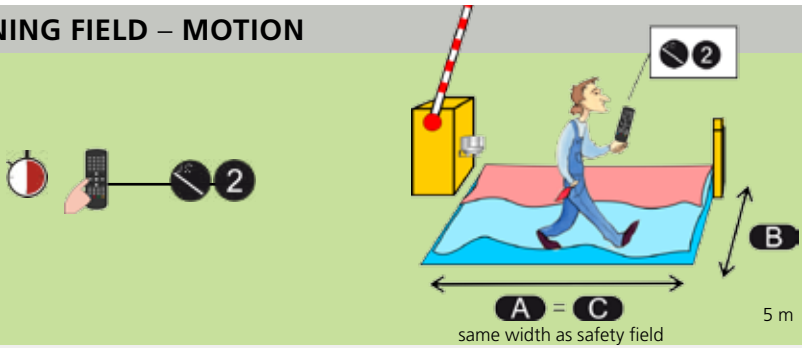

TEACH-IN

The opening field can be adapted more precisely by launching a teach-in (the sensor learns the environment). Before launching a teach-in, make sure that the selected field size is bigger than the desired field size.



The detection field should be free of snow buildups, heavy rain, snowfall, fog, or other moving objects.

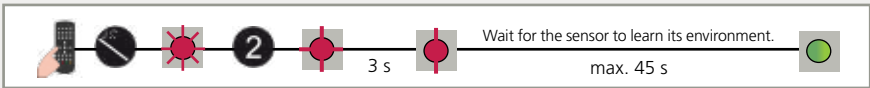

During the teach-in (45 sec.), the sensor records the reference distances to all objects within its detection zone.

If you walk along the detection area while the teach-in function is active, the sensor memorizes the outline of the walk path and stores this as a new detection field. The shortest distance measured by each laser beam is stored by the sensor and determines the field limit.

You can increase or decrease the field by 10 cm:



FIELD DIMENSIONS

Adjust the field dimensions if you want to get a rectangular field.

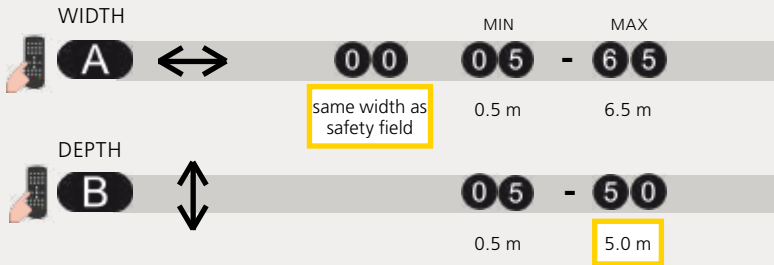

EX: A 4 5 for a field width of 4.5 m

If the 1st red LED (motion) stays ON and no moving objects are in the detection field, reduce the opening impulse field size or launch a new teach-in.

OPTIONAL REMOTE CONTROL ADJUSTMENTS

FACTORY VALUES

MAX. PRESENCE TIME
opening field

	0	1	2	3	4	5	6	7	8	9
	off	5 s	10 s	30 s	1 min	2 min	5 min	10 min	2 h	infinite

During detection, the sensor automatically switches from motion to presence detection for a given presence time. Once the object has left the detection field, the presence time is aborted.

DETECTION TRAJECTORY
opening field

	bidirectional detection approaching and going away	BIDIRECTIONAL	1
	unidirectional detection only approaching in any direction	400% CENTER	2
	unidirectional detection only approaching towards the barrier/gate	200% CENTER	3
	unidirectional detection only approaching within width of barrier/gate	100% CENTER	4
	unidirectional detection only approaching towards central zone of barrier/gate	50% CENTER	5
	unidirectional detection only approaching towards centre of barrier/gate	25% CENTER	6
	unidirectional detection only approaching towards right side	100% RIGHT	7
	unidirectional detection only approaching towards left side	100% LEFT	8

DETECTION DELAY
opening field

	0	1	2	3	4	5	6	7	8	9
	off	100	200	300	400	500	600	700	800	900

approximate values, in milliseconds

OPTIONAL REMOTE CONTROL ADJUSTMENTS (cont.)

 FACTORY VALUES

SAFETY FIELD REDIRECTION

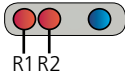

F1	0	1	2
RELAY 1	motion	motion or presence	motion + presence
RELAY 2	presence	presence	presence

OUTPUT CONFIGURATION

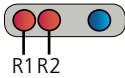



	1	2	3	4
RELAY 1	A - NO	P - NC	P - NC	A - NO
RELAY 2	P - NC	A - NO	P - NC	A - NO

A = active P = passive

IMMUNITY

	1	2
	low	high

MAGIC WAND

	0	1	2	3
		teach-in safety field	teach-in opening field	
	9			
	factory values	visible laser beams		

TROUBLESHOOTING

	No blue LED	No power	Check cable and connexion.
		Polarity of power supply is inverted	Check the polarity of the power supply.
		All LEDs have been deactivated by remote control	Activate LEDs using remote control.
	Detection LED remains green	Detection field too small or deactivated	Check size of fields. Launch a teach-in.
	Detection LED remains red	Someone/Something is in the detection field	Step out of the field and/or remove the any object(s) from the field.
		Field is touching floor/wall/ barrier – this leads to detection	Activate the 3 red beams and check if the position of the sensor is correct. If not, adjust the hex screws. Verify the field size. Launch a teach-in.
	Orange LED flashing and detection LEDs are red	No background (reference point) is found	Check position of sensor. Check the mounting side setting. If no reference point is found, set the mounting side to value 3 or 4. Launch a new teach-in.
		Sensor is masked	Verify and clean the front screens with a damp cloth.
	Orange LED is on	Power supply voltage exceeds acceptable limits	Check power supply voltage.
		Sensor exceeds temperature limits	Verify the temperature of the environment. Protect the sensor from sunlight using a cover, if necessary.
		Internal error	Wait a few seconds. If the LED remains ON, reset the power supply. If the LED turns on again, replace the sensor.
	Sensor does not respond to the remote control	Remote control batteries not installed properly or are dead	Check battery orientation or replace the batteries.
		Remote control not pointed correctly	Point the remote control towards the sensor, but with a slight angle. The RC should not be pointed in a right angle in front of the sensor.
		Reflective object is close to the sensor	Avoid highly reflective material in proximity to the sensor.
	Sensor does not unlock	Access code needs entered or an incorrect code was used	Cut and restore power supply. No code is required to unlock during the first minute after powering.

TECHNICAL SPECIFICATIONS

Technology:	laser scanner, time-of-flight measurement			
Detection mode:	motion and presence			
Max. detection range:	5.0 m x 6.5 m (16 ft 6 in x 21 ft)			
Remission factor:	> 2%			
Angular resolution:	0,3516°			
Emission characteristics				
IR laser:	wavelength 905 nm; max. output pulse power 75 W (CLASS 1)			
Red visible laser:	wavelength 650 nm; max. output CW power 3 mW (CLASS 3R)			
Supply voltage:	10 – 35 VDC @ sensor side			
Power consumption:	< 5 W			
Peak current @ power-on:	1.8 A (max. 80 ms @ 35 V)			
Cable length:	10 m (30 ft)			
Response time				
Motion detection:	typ. 200 ms (adjustable)			
Presence detection:	typ. 20 ms (max. 80 ms)			
Output:	2 electronic relays (galvanic-isolated – polarity-free)			
Max. switching voltage:	35 VDC / 24 VAC			
Max. switching current:	80 mA (resistive)			
Switching time:	t _{ON} =5 ms; t _{OFF} =5 ms			
Output resistance:	typ 30 Ω			
Voltage drop on output:	< 0.7 V @ 20 mA			
Leakage current:	< 10 μA			
Input:	1 optocoupler (galvanic-isolated – polarity-free)			
Max. contact voltage:	30 VDC (over-voltage protected)			
Voltage threshold:	Log. H: >8 VDC Log. L: <3 VDC			
LED signal:	1 blue LED: power-on status 1 orange LED: error status 2 bi-coloured LEDs: detection/output status (green = no detection, red = detection)			
Dimensions:	5.0 in (D) x 3.6 in (W) x 2.75 in (H) (mounting bracket + 0.55 in)			
Material:	PC/ASA			
Color:	Black			
Mounting angles on bracket:	-45°, 0°, 45°			
Rotation angles on bracket:	-5 – 5° (lockable)			
Tilt angles on bracket:	-3 – 3°			
Protection degree:	IP65			
Temperature range:	-30 – 60 °C if powered		-10 – 60 °C if unpowered	
Humidity:	0 – 95% non-condensing			
Vibrations:	< 2G			
Pollution on front screen:	max. 30%, homogenous			
Norm conformity:	2006/95/EC: LVD 2002/95/EC: RoHS	2004/108/EC: EMC EN 60529:2001	IEC 60825-1:2007 EN 60950-1:2005	EN 61000-6-2:2005 EN 61000-6-3:2006

Specifications are subject to change without prior notice. All values measured in specific conditions.

BEA INSTALLATION/SERVICE COMPLIANCE EXPECTATIONS

BEA, the sensor manufacturer, cannot be held responsible for incorrect installations or inappropriate adjustments of the sensor/device; therefore, BEA does not guarantee any use of the sensor outside of its intended purpose.

BEA strongly recommends that installation and service technicians be AAADM-certified for pedestrian doors, IDA-certified for doors/gates, and factory-trained for the type of door/gate system.

Installers and service personnel are responsible for executing a risk assessment following each installation/service performed, ensuring that the sensor system installation is compliant with local, national, and international regulations, codes, and standards.

Once installation or service work is complete, a safety inspection of the door/gate shall be performed per the door/gate manufacturer recommendations and/or per AAADM/ANSI/DASMA guidelines (where applicable) for best industry practices. Safety inspections must be performed during each service call – examples of these safety inspections can be found on an AAADM safety information label (e.g. ANSUDASMA 102, ANSVDASMA 107, UL 325).

Verify that all appropriate industry signage and warning labels are in place.









BEA hereby declares that the LZR®-I100/-I110 is in conformity with the basic requirements and the other relevant provisions of the directives 2006/95/EC, 2002/95/EC, 2004/108/EC and 2006/42/EC.
 Notified Body for EC inspection: 0044 - TÜV NORD CERT GmbH, Langemarkstr. 20, 45141 D-Essen
 EC-type examination certificate number: 44 205 11 392410-002
 Angleur, May 2011 Jean-Pierre Valkenberg, Authorized representative and responsible for technical documentation
 The complete declaration of conformity is available on our website: www.bea-industrial.be
 For EC countries: according to the directive 2012/19/EU for Waste Electrical and Electronic Equipment (WEEE)

Tech Support: 1-800-407-4545 | Customer Service: 1-800-523-2462 | General Tech Questions: Tech_Services@beainc.com | Tech Docs: www.BEAinc.com

PLEASE KEEP FOR FURTHER USE – DESIGNED FOR COLOR PRINTING

75.5897.02 LZR-H110 20170821 | Original Instructions

©BEA | HALMA COMPANY