

# Mounting and installation manual

## Sliding gate operator TPS 40 PRO

V 2.6.006



**tousek**<sup>®</sup>  
G A T E A U T O M A T I O N



## Index

---

	General warning and safety notes.....	3
1.	General product features, function, technical data .....	4
2.	Installation .....	5
	Emergency release in case of power failure (note for the user).....	9
3.	Control box .....	10
	Programming, Menu structure .....	14, 15
	Connections and adjustments .....	16
	Switches/buttons.....	16
	Safety.....	18
	Safety edges.....	20
	Motor.....	22
	Operating mode .....	23
	Lights/lamps.....	25
	Diagnosis .....	26
4.	Connection of radio receiver .....	27
5.	Putting into operation .....	28
6.	Troubleshooting guide.....	31
7.	Cable plan .....	32
8.	Dimensioned drawings .....	33
	Declaration of incorporation .....	35



## GENERAL WARNING AND SAFETY NOTES

- These installation and operating instructions form an integral part of the product “sliding gate operator”. They have been specifically written for professional installers trained and skilled in the trade and should be carefully read in their full length before carrying out the installation. They describe the proper installation and operation of the sliding gate operator only, not of the overall device “automatic gate”. After the installation this manual has to be handed over to the user.
- **Installation, connection, adjustments, putting into operation, and servicing may only be carried out by trained professionals in full accordance with these installation- and operating instructions.**
- Before carrying out works at the gate-system, the power supply has to be turned off.
- The EU Machine Directive, laws and rules concerning the prevention of accidents, and laws and standards which are in force in the EU and in the individual countries have to be strictly followed.
- The TOUSEK Ges.m.b.H. cannot be held liable for any claims resulting from disregards of the laws and standards in force during the installation and operation.
- The packaging materials (cardboard, plastic, EPS foam parts and filling material etc.) have to be properly disposed of in accordance with the applying recycling- and environmental protection laws. They may be hazardous to children and therefore have to be stored out of children’s reach.
- The product is not suitable for installation in explosion-hazardous areas.
- The product may only be used in accordance with its original purpose, for which it has been exclusively designed, and which is described in these installation and operating instructions. The TOUSEK Ges.m.b.H. rejects any liability if the product is used in any way not fully conforming to its original purpose as stated herein.
- Children have to be instructed, that the gate facility as well as the belonging parts may not be used improperly, e.g. for playing. Furthermore handheld transmitters have to be kept in safe places and other impulse emitters as buttons and switches have to be installed out of children’s reach.
- Before beginning with the installation the installer has to make sure that all mechanical components of the gate facility, like carrier profile/rail, gate frame and panels, guiding elements etc. are sufficiently supportive and resistant for the purpose of gate automation.
- All electrical installations have to be made in full conformity with the applying rules and laws (e.g. using a fault current circuit breaker, proper grounding etc.).
- An all-pole disconnecting main switch with a contact opening-gap of minimum 3 mm has to be foreseen.
- The electric motor heats up during operation. Therefore the device should only be touched after it has cooled off.
- **After installation the proper function of the gate facility and the safety devices has to be checked!**
- The TOUSEK Ges.m.b.H. rejects any liability for claims resulting from usage of the product in combination with components or devices which do not fully conform to the applying safety laws and rules.
- Only original spare- and replacement parts may be used for repair of the product.
- The installer has to inform the user about all aspects of the automatic operation of the complete gate facility, as well as about emergency operation. The installer further has to supply to the user all instructions relating to the safe operation of the gate facility. The installation and operating instructions also have to be handed over to the user.
- **Please notice that the warranty will not be applicable if the label with the engine number has been removed or damaged.**



## Maintenance

- **Maintenance works may only be carried out by qualified personnel.**
- **Check the proper sensitivity setting of the ARS safety reverse system once a month.**
- **Check the proper function of the emergency release mechanism periodically.**
- **Check if all mounting screws are securely fastened periodically.**
- **Remove dirt deposits from the operator and gear rack periodically.**
- **Maintenance and servicing of the complete gate facility has to be carried out according to the gate builder’s/ installer’s instructions.**

## Product features TPS 40 PRO

TPS 40 PRO

- Suitable for heavy duty use (100% duty/cycle)
- Large, illuminated LC-Display (2x16 characters)
- Clear text menu programmable via four buttons
- Operation mode is selectable (Impulse, Automatic, Deadman)
- Free adjustable partial opening for pedestrians or car/truck function
- Distance measurement via absolute encoders (no limit switches), no need of learning the way after unlocking or blackout.
- Adjustable soft stop (distance and speed)
- Adjustable speed (separately for OPEN and CLOSE), controlled by a frequency converter
- Mechanical brake for safe gate stop
- Electronic monitoring of the emergency release
- Direct connection of four separate 8,2 kΩ safety contact edges
- Input for gate back area surveillance
- Status display for safety and impulse connections
- Self-monitoring of photocell
- Connection slot for radio receiver
- Optional, external gate status display (e.g. for concierge)
- Optional courtyard lamp module (230V, 100W)
- integrated main switch and 230V Schuko socket
- Optional height-adjustable fork and bracket for signal transmission system
- Dimension (W x H x D): 520 x 995 x 230mm
- Height adjustment gear wheel (upper edge): 143–173,5mm
- gear wheel Z13M6



## Function

TPS 40 PRO

The integrated control unit can be adjusted in 3 logic modes:

- **Impulse mode:** with open and close button/switch function
- **Automatic mode:** automatic closing
- **Dead-man mode:** gates moves as long as switch/button is pressed
- **Emergency mode:** Deadman mode without safety devices (in case of malfunction or failure)

With the connection possibility of buttons OPEN/CLOSE/STOP, photocells and entrance protection as well as switch for pedestrian entry. This one opens the gate partially. The partial opening is adjustable. For control of a light signal a 230V output is available for connection of a signal lamp. The control board is also equipped with connection slots for a radio receiver board and an additional module (for courtyard/control lamp or gate status).

## Technical data

Sliding gate operator TPS 40 PRO			
Control unit	integrated	Max. drive	30m
Power supply	230V a.c. ±10%, 50Hz	duty cycle in S1 mode	100%
motor voltage	400V	Ambient temperature	-20°C bis +50°C
max. current consumption (excl. equipment)	3A	Protection class	IP44
Gear wheel	Z13M6	Force adjustment	frequency converter
Max. gate weight	4000kg	Article no.	11110760
Speed	17,5m/min		
Torque	100Nm		
Optional equipment	pluggable receiver • additional module for courtyard/control lamp • additional module for gate status • radio transmission system TX 310 • inductive system TX 400i • safety sensing edge TXK 65 • photocell LS 45/2		



**An all-current sensitive FI circuit breaker (Type B) is necessary for proper operation!**

**DANGER**

- **Please note that due to the big mass of the gate and its high speed, a huge kinetic energy is generated. This must be necessarily taken into account when planning and constructing the gate. The limit stops and the mechanical construction have to be dimensioned accordingly!! With the cantilever system LWS 125 absolutely use the end stops with art. no. 14650330.**
- **ATTENTION:** The sliding gate operator has been developed and designed for the automation of horizontally travelling sliding gates. Gates on sloping tracks (i.e. gates which follow an inclined, non-horizontal, travel path) must be automated with additional safety devices (which make sure that the gate cannot start moving on its own from any gate position).



General installation notes

Before installing the **tousek TPS 40 PRO** sliding gate operator we recommend checking the following points:

- **Checking the gate structure:**  
**On a gate which travels on floor rails please check the bottom rollers and the upper guide rollers and make sure that there is no undue friction or jamming.**  
**On a cantilever gate please check if the gate can be moved out of its end-positions without undue effort.**
- The gate must travel in a stable manner without lateral movements of the gate panel.
- Make sure that the gate travels in a regular way without undue friction or jamming along the whole travel length.
- **Make sure that there are stoppers at both ends of the track, preventing the gate from running over its travel limit.**

Technical layout TPS 40 PRO

- |                                      |   |   |
|--------------------------------------|---|---|
| (1) Ground plate                     | (6) Motor-/gear unit  | (9a) Slot for fork bracket for power supply systems |
| (1a) Cable inlet                     | (7) Optional photocell LS 45/2  | (10) Safety sensing edges (optional)                |
| (1b) Slotted holes (4x) for mounting | (7a) Opening for photocell  | (11) Cabinet lock (profile half cylinder)           |
| (2) Gear wheel Z13M6                 | (8) Main switch   |   |
| (3) Emergency release                | (9) Height adjustable bracket for signal transmission system (optional) |   |
| (4) Control unit                     |   |   |
| (5) Speed sensor                     |   |   |

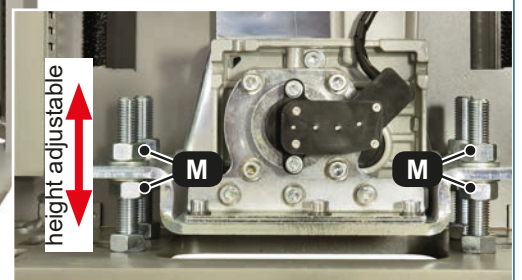

Height adjustability of the motor (gear wheel)

- The motor is height adjustable: the gear wheel height can be adjusted by means of nuts (M) - After adjustment, please tighten the nuts again.

After installing the protection tubes (**check cable exit of operator (1a)**) and having finished the concrete foundation, the motor has to be bolted through the 4 slotted holes (**1b**) to the concrete foundation. It is particularly important that the operator is mounted parallel to the gate panel, and that the measurements given in the drawing are kept.



### NOTE concerning cable laying

- The electric cables have to be laid in insulating sleeves which are suitable for underground usage. The insulating sleeves have to be lead into the inner of the operator housing (see picture).
- 230V cables and control lines have to be laid in separate sleeves.
- Only double-insulated cables, which are suitable for underground usage (e.g. E-YY-J) may be used.
- In case that special regulations require another type of cable, cables according to these regulations have to be used.

### Mounting dimensions TPS 40 PRO (in mm)

- (1) Ground plate  
 (1a) Cable inlet  
 (1b) Slotted holes (4x) for connection on the ground  
 (2) Gear wheel Z13M6

#### height of gear wheel adjustable:

center: 98–128,5mm  
 top: 143–173,5mm

Dimensions in mm

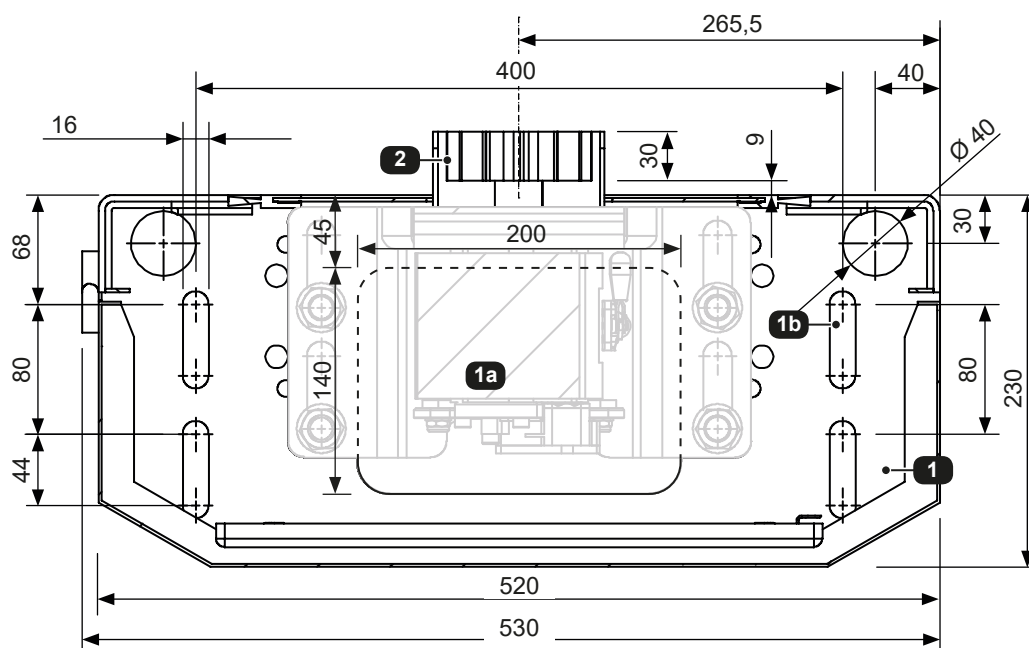

We reserve the right to change dimensions and technical specifications without prior notice!



## 2.2 Mounting the fork for the power supply system (optional)

- If you plan to use a power supply system, we recommend installing the optional fork (9).
- The fork, which is adjustable in height and depth, is stuck with its brush (B) through one of the openings through the brush (B).

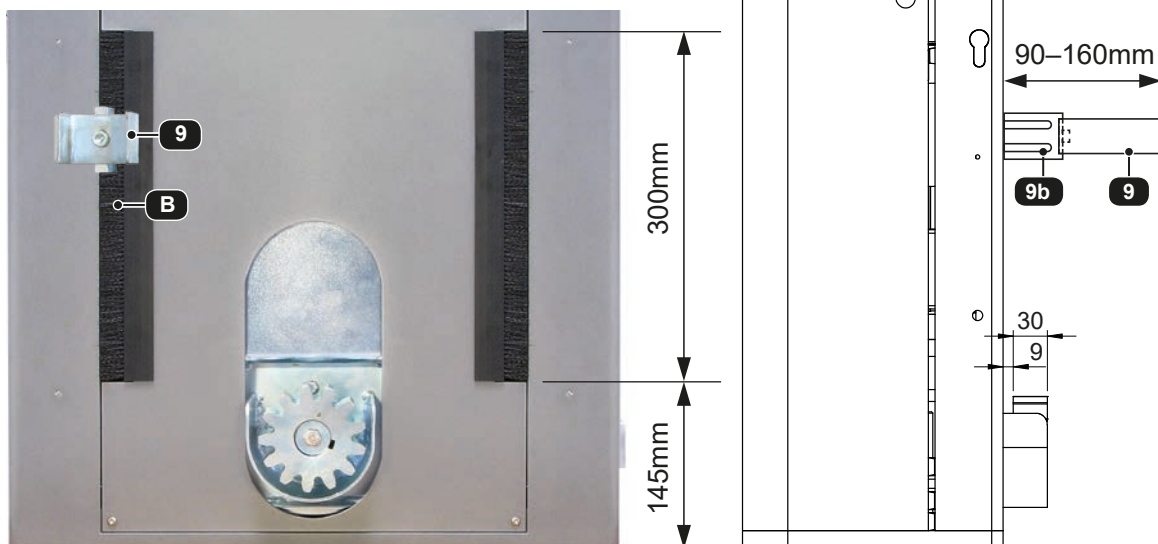

- Thereafter, push the screw piece (S) into the rail that runs along the brush inside the housing, and screw the fork support (9b) by means of two hexagon socket screws.

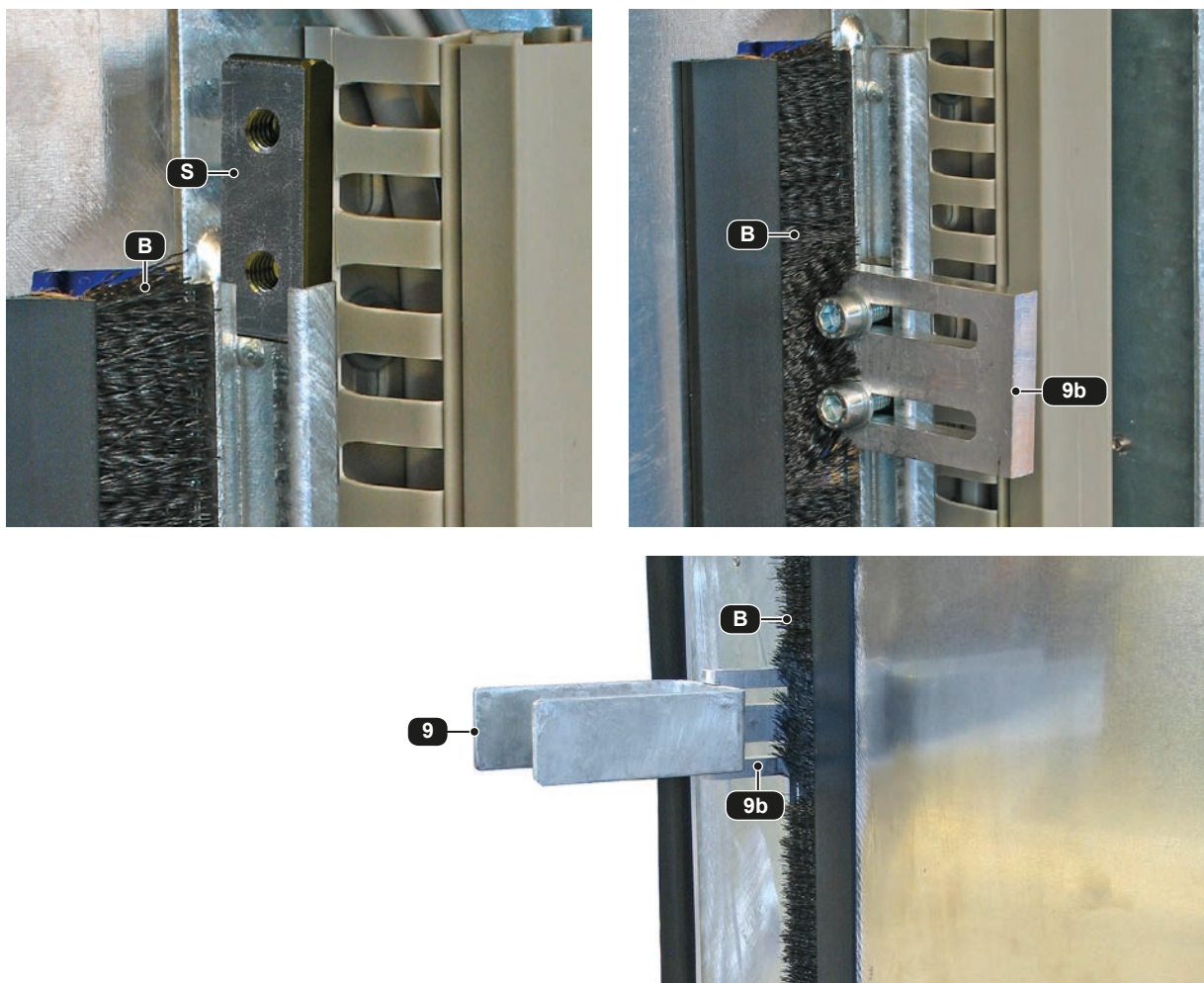

## 2.3 Installation of the gear rack

- Disengage the motor from the output drive pinion with the emergency release lever (see emergency release for instructions) and open the gate completely.
- Fix the mounting angles (**W**) on the steel gear rack elements (**Z**) using the enclosed washers and bolts (**S**).
- Place the first gear rack element on the drive pinion and fix it in place with a screw clamp.
- Move the gate by hand until reaching the end of the first gear rack element.

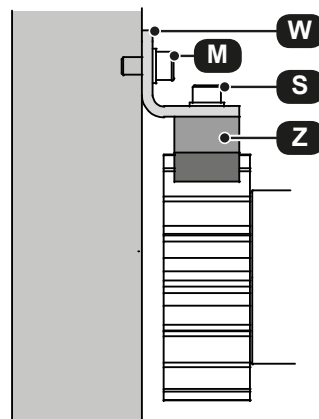

- The bolts (**M**) for fixing the mounting angles (**W**) to the gate have to be positioned on the top of the vertical slots (**L**).
- Proceed with the other gear rack elements in the same manner.

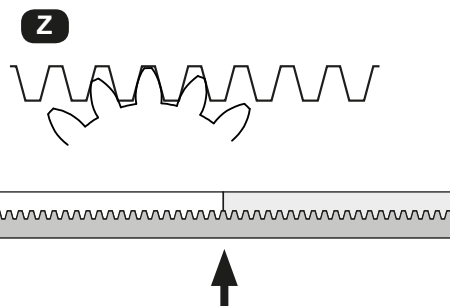
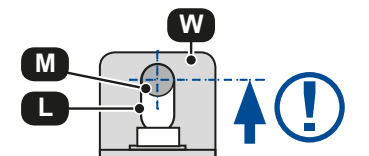

Before fixing the second meter of gear rack it is essential to place another gear rack element under the first and second gear rack elements, thereby making sure that the gearing module between the two gear rack elements will be exactly kept (see illustration).



- After installation of the gear rack please loosen the bolts (**M**) slightly and rise the gear rack a little along the vertical slots, creating a **distance of approx. 1 mm** between the flank of the drive pinion and the gear rack.
- After that fix the angles again with the bolts (**M**).

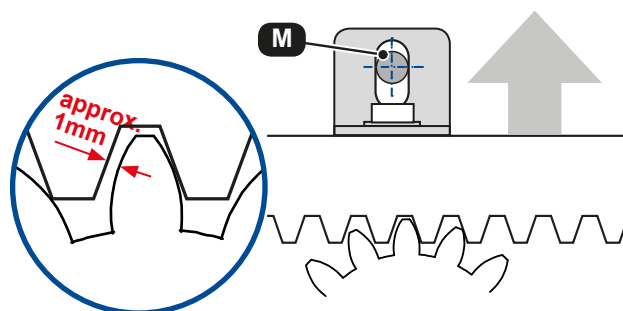

### Attention

**Do not weld the individual gear rack elements together!**



In case of a power failure or other defect the drive pinion can be disengaged from the gearmotor as follows:

- Turn the lever counterclockwise (180 °) until it stops.
- Now the gate can be opened and closed manually.
- Turn the lever back to restore engine operation.



## 2.5 Dismantling

The dismantling of motor is made the other way around of mounting.



**Before dismantling plug off power supply of motor !**



## Warning

- Before removing the control cover, the mains switch must be turned off!
  - If the control is power supplied, its inner part is under voltage.
  - In order to avoid electrical strokes, the safety regulations have to be kept.
  - The device may only be connected by trained professionals.
- 
- The product is not suitable for installation in explosion-hazardous areas.
  - An all-pole disconnecting mains switch with a contact opening gap of min. 3 mm has to be foreseen. The gate facility has to be secured according to the valid safety regulations!
  - **IMPORTANT:** The control lines (sensor, buttons, radio, photocells, etc.) have to be laid **separately from the 230V lines** (supply line, motors, signal lamp).



An all-current sensitive FI circuit breaker (Type B) is necessary for proper operation!



## DANGER NOTES - Use of frequency converter

- Read this manual carefully before installing and using the converter. Installation, adjustment, repair and maintenance have to be made by professional staff.

> **The non-compliance of the following instructions leads to death or perilous injuries !!!**

## LOOK UP TO CONTINUOUS EARTHING

- An oxidated cooling element can form a confining layer to the mounting plate. Take implicitly the suggested earthing connections into account!

## ACCIDENTAL USE OF DEVICE

- Read this manual carefully before installing and using the converter.
- Adjustment of parameter settings have to be done by trained professionals.

## DANGER OF ELECTRIC SHOCK OR ELECTRIC ARC AND EXPLOSION

- Read this manual carefully before installing and using the converter. Installation, adjustment, repair and maintenance have to be made by professional staff.
- The user is responsible for the compliance of all relevant international and national electrotechnical rules/requirements regarding the protection earthing of all devices.
- Numerous components of the frequency converter, including the printed circuits boards, are being supplied through the mains voltage. DO NOT TOUCH ! Only use electrically isolated tools.
- **Do NOT touch non** shielded elements or bolt connections at terminals with mains voltage on
- **DO NOT short-out** the clamps PA/+ and PC/- or the DC-Bus-condensers.
- Before maintenance of converter:
  - Cut off any power supply (also external of control device).
  - Put a warning signboard with „DO NOT TURN ON“ onto the power switch or circuit breaker.
  - Lock the power switch or circuit breaker in open position.
  - WAIT 15 MINUTES so that the PC-Bus-condensers can discharge.
  - Measure the voltage supply of DC-Busses between clamps PA/+ and PC/-, to make sure that the voltage is under 42 Vd.c. The LED's of converter can not show whether there is no DC-bus supply.
  - Should the DC-Bus-condensers not fully discharge please contact manufacturer. Do not try to repair yourself.
- Mount all covers and before switching on the supply or before starting and stopping the converter.

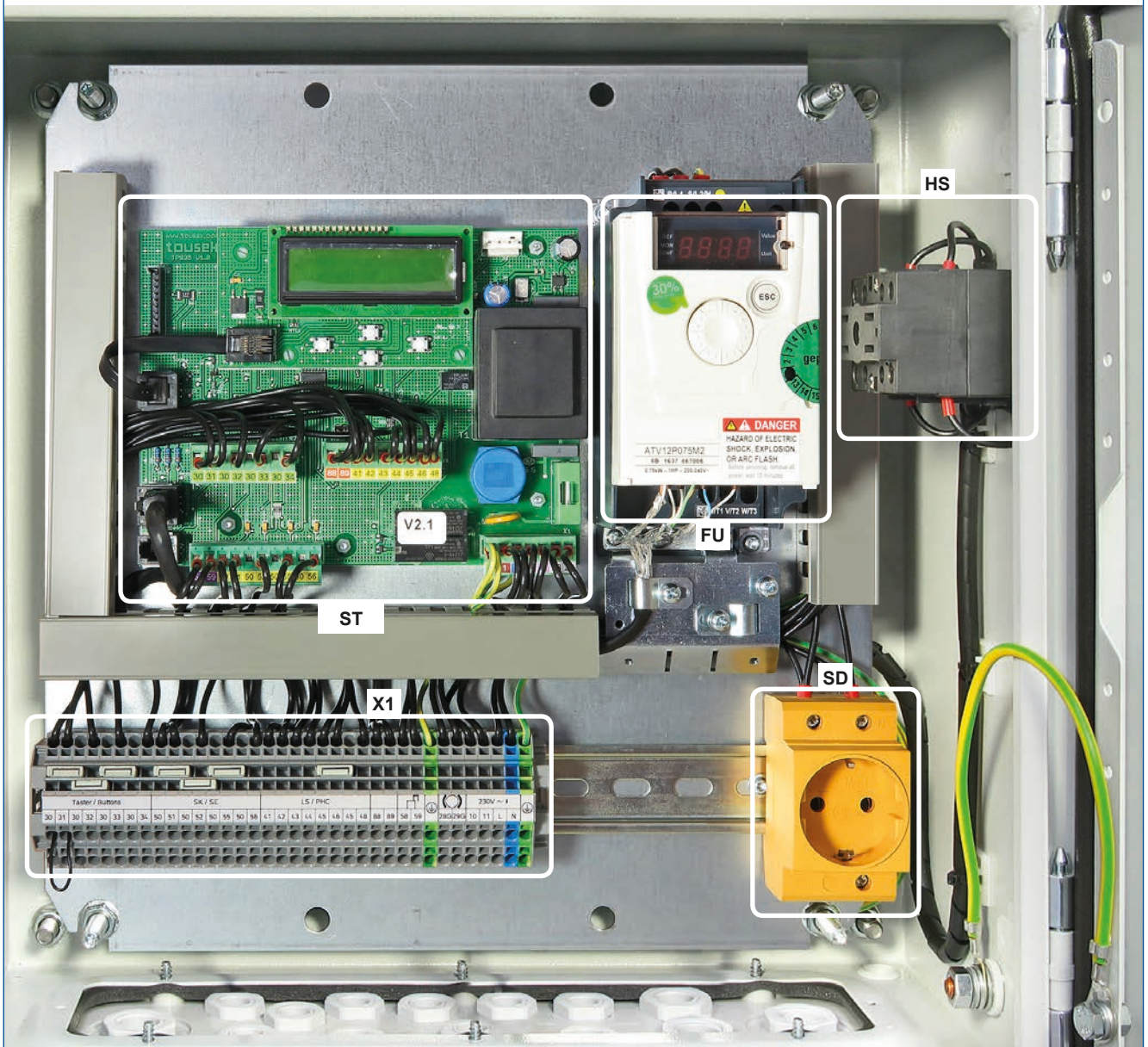

#### Components of the control box

<b>FU</b>	Frequency converter
<b>HS</b>	Main switch
<b>X1</b>	Terminal block
<b>SD</b>	230V Schuko socket
<b>ST</b>	Control circuit board with display and four programming buttons +, -, ENTER und ESC



The TPS 40 PRO has a terminal block X1. All connections have to be done at this block, which is internally connected with the control board ST.



An all-current sensitive FI circuit breaker (Type B) is necessary for proper operation!



### Overview



### Attention

During connection, adjustment and maintenance works please take care, that the electronic circuit board won't be damaged by moisture (rain).



All connections have to be done at the terminal block X1, which is internally connected with the control board ST.

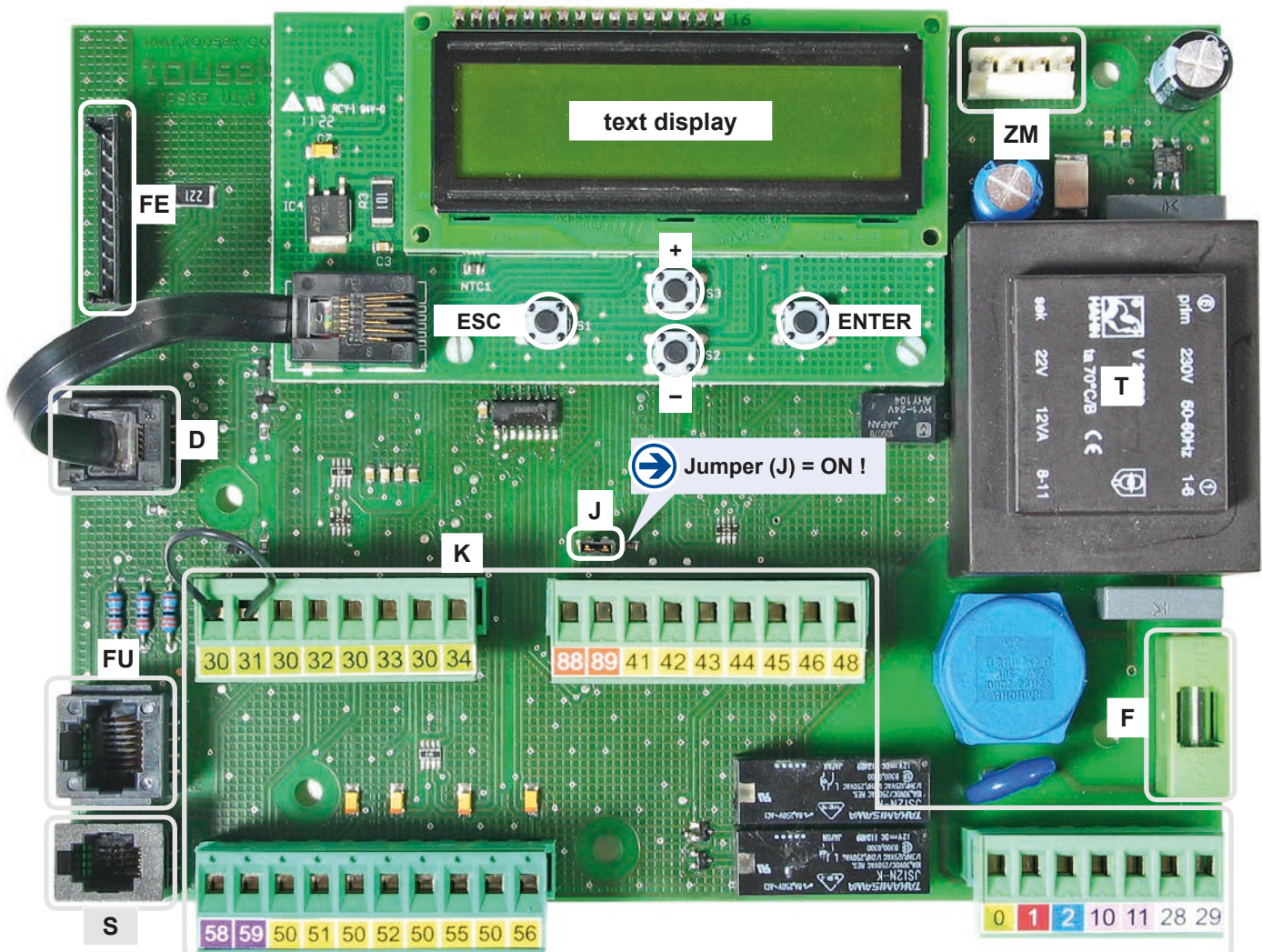

### Elements of control board

- (K) Terminal blocks
- (D) Display plug or TC-/TSI-connection  
(optional „tousek-connect“ / „tousek service Interface“)

- (FU) Frequency converter
- (S) Sensor plug
- (FE) Slot for optional radio receiver  
([☞ page 27](#))
- (ZM) Connection slot for optional module  
([☞ page 24](#))
- (F) Fuse T 1A
- (T) Transformer
- (J) Jumper (**must be set !**)



### Important

The optional „tousek-connect“ or the „tousek service interface“ must be connected with socket (D)!



#### terminal block X1 of TPS 40 PRO

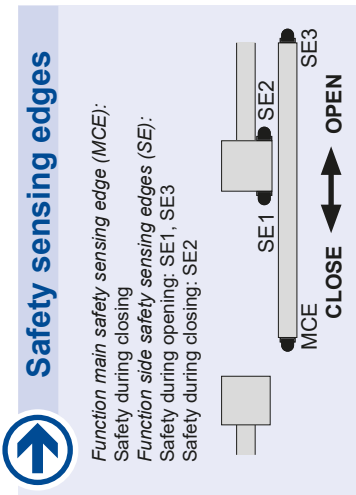

If no stop switch is connected, terminals 30/31 have to be wire-bridged (the jumper is set in the factory).

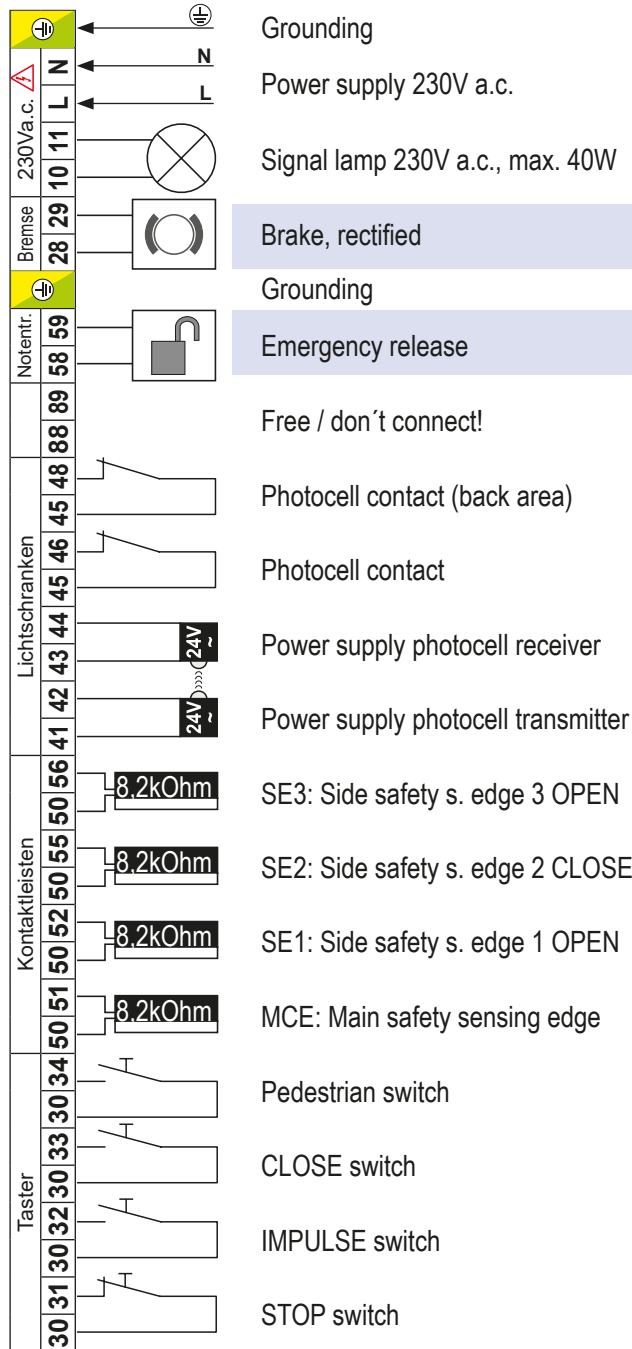

prewired

- Emergency release
- Brake, rectified

The stop input has no emergency stop function! - In order to ensure the emergency stop function, provide the supply line with an all-pole disconnecting emergency stop switch, that locks after actuation!



## Programming buttons

## Adjustments - overview



- The adjustment (programming) of the operating parameters is carried out with four programming buttons and the display.
- Before starting the programming, please choose the language. Use the buttons **+** or **-** to choose menu language and confirm with **ENTER**.
- **Note: Language selection can also be chosen by pressing the ESC button for 5s, from any position in menu.**

- The text display informs about behaviour, chosen menus and adjustment of different settings.
- The programming of the control is carried out with the help of four buttons (**+**, **-**, **ENTER** und **ESC**).
- Scrolling through the available menu points (up/down) or the adjustment of a parameter (value increase/decrease) is carried out with buttons **+** and **-**.. **AUTO-COUNT:** when holding one of the buttons the value changes automatically.
- When pressing the **ENTER**-button a confirmation for entering the shown menu point, resp. for accepting the shown value of a parameter is given.
- When pressing the **ESC**-button you return to the superior menu point. Possibly changed adjustments of a parameter are rejected with this button (the former values will remain).
- **AUTO-EXIT:** if no button is pressed during 1 min. then the menu switches automatically to the "ready" menu (without saving changed parameters)

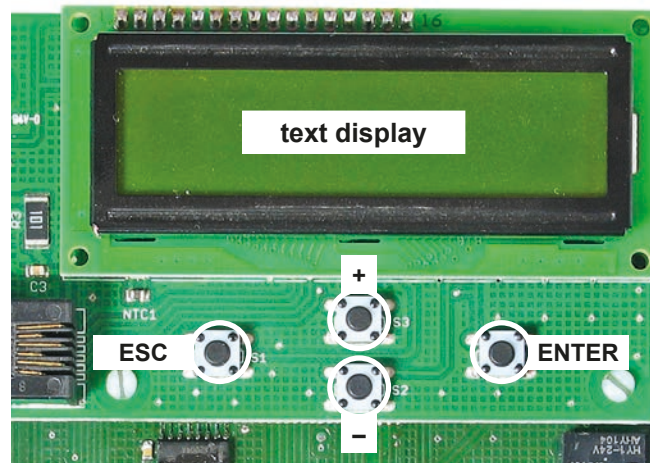

## Programming menu

## Adjustments - overview



- The program menu is divided into „POSITIONING“ „BASIC SETTINGS“ and „ MENU CONTROL“

### Positioning

- ⊙ **Automatic:** the final positions are determined automatically, i.e. the positions, where the gate gets stopped by the mechanical stops, are learned as final positions. When using the factory settings the gate stops short before the limit stops (adjustable through function „end position OPEN (CLOSE)“).
- **Manually:** the gate is manually brought to the desired OPEN and CLOSED position. These two positions are confirmed as end positions by giving an impulse (radio, button). When using the factory settings, the gate stops exactly at these positions (can be adjusted with function „end position OPEN (CLOSE)“ ).

The choice of the positioning mode (automatically or manually) takes place at the beginning of the programming process. Afterwards this menu point gets hidden and can be selected either by resetting to factory settings or by deleting positions.

### BASIC SETTINGS

- **When entering the programming of the control unit for the first time you will see the BASIC SETTINGS after POSITIONING.** (see *putting into operation* page 28).
- Here the necessary adjustments for the use of the operator/gate can be set quickly.
- For advanced settings/programming please choose the menu point „menu control“.

### MENU CONTROL

- For further programming you will reach immediately the MENU (CONTROL) (Basis settings are skipped)
- The menu control includes all kinds of settings.



The different menu points are indicated as follows:

○ = selectable settings    ⊙ = factory settings    ⇨ = status display

shows the menu points which are in the "BASIC SETTINGS"

Note: some adjustments regarding function or operating logic can only be executed if gate is closed and if the display shows „ready“.



1) The menu points courtyard lamp and control lamp will only appear on display if in menu „Additional module“ ☉ courtyard lamp/control lamp is selected.

positioning		<input type="radio"/> automatic <input type="radio"/> manually	Will disappear after entering, again selectable either after resetting or by deleting the positions.	
Basic settings	photocell	<input type="radio"/> active <input type="radio"/> not active		
	Main clos. edge	<input type="radio"/> active <input type="radio"/> not active <input type="radio"/> radio edge <input type="radio"/> TX 400		
	side edge 1 OPEN	<input type="radio"/> active <input type="radio"/> not active		
	operating mode	<input type="radio"/> impulse mode <input type="radio"/> aut. close 5...255s [ increment 5 ]		
	opening direction	<input type="radio"/> <<<- left <input type="radio"/> ->> right	Appears only for automatic positioning.	
	menu control	ENTER: Entry in the main menu (Return to the default setting from the main level of the main menu with ESC)		
<b>Menu control</b>				
<b>Main layer</b>	<b>Sub layer</b>	<b>Settings/adjustments</b>		
buttons/switches page 16	impulse button	<input type="radio"/> OPEN/STOP/CLOSE <input type="radio"/> OPEN/CLOSE/OPEN <input type="radio"/> OPEN <input type="radio"/> DEAD MAN	*) if impulse button is set to DEADMAN, then the pedestrian and close button are also set automatically to DEADMAN mode. (not selectable under „pedest.-button“)	
	pedestrian func.	<input type="radio"/> partial opening <input type="radio"/> impulse OPEN		
	pedestrian button	<input type="radio"/> OPEN/STOP/CLOSE <input type="radio"/> OPEN/CLOSE/OPEN <input type="radio"/> OPEN <input type="radio"/> DEAD MAN *)		
	emergency mode	<input type="radio"/> not active <input type="radio"/> active		when emergency mode is active → DEADMAN mode with impulse button is not possible.
	illumination 10s	<input type="radio"/> not active <input type="radio"/> active		
safety page 18	photocell	<input type="radio"/> active <input type="radio"/> not active		
	PHC- back area	<input type="radio"/> not active <input type="radio"/> active		
	PHC-function	<input type="radio"/> when closing reverse <input type="radio"/> stop, after release open <input type="radio"/> during closing stop, then close		
	PHC- pause time	<input type="radio"/> no influence of photocell <input type="radio"/> abort pause time <input type="radio"/> re-start pause time <input type="radio"/> immediate close after opening		
safety edges page 20	PHC- self test	<input type="radio"/> active <input type="radio"/> not active		
	Main clos. edge	<input type="radio"/> active <input type="radio"/> radio edge <input type="radio"/> TX 400 <input type="radio"/> not active		
	Side edge 1 OPEN	<input type="radio"/> active <input type="radio"/> not active		
	Side edge 2 CLOSE	<input type="radio"/> active <input checked="" type="radio"/> not active		
	Side edge 3 OPEN	<input type="radio"/> active <input type="radio"/> radio edge <input type="radio"/> TX 400 <input type="radio"/> not active		
motor page 22	SE-status display	status display of safety sensing edges		
	speed OPEN	<input type="radio"/> 50...100% [ increment 5 ] <input checked="" type="radio"/> = 100%		
	speed CLOSE	<input type="radio"/> 50...100% [ increment 5 ] <input checked="" type="radio"/> = 80%		
	soft speed	<input type="radio"/> 25...90% [ increment 5 ] <input checked="" type="radio"/> = 50%		
	soft path OPEN	<input type="radio"/> 0...200cm [ increment 10 ] <input checked="" type="radio"/> = 50cm		
	soft path CLOSE	<input type="radio"/> 0...200cm [ increment 10 ] <input checked="" type="radio"/> = 50cm		
	soft stop	<input type="radio"/> active <input type="radio"/> not active		
	end position OPEN	<input type="radio"/> +30...0...-30 [ increment 1 ] <input checked="" type="radio"/> = -5 <input type="radio"/> = 0 for manual positioning		
	end position CLOSE	<input type="radio"/> +30...0...-30 [ increment 1 ] <input checked="" type="radio"/> = -5		
	operating mode page 23	impulse mode	<input type="radio"/> stop, start of pause time <input type="radio"/> impulse suppression when opening <input type="radio"/> pause time extension	
opening direction		<input type="radio"/> <<<- left <input type="radio"/> ->> right	Appears only for automatic positioning.	
operating mode		<input type="radio"/> impulse mode <input type="radio"/> aut. close 1...255s [ increment 1 ]		
partial opening		<input type="radio"/> 10...100% [ increment 1 ] <input checked="" type="radio"/> = 30%		
automatic mode		<input type="radio"/> complete/partial opening <input type="radio"/> only complete opening <input type="radio"/> only partial opening		
pause time logic		<input type="radio"/> no influence <input type="radio"/> always open in automatic mode		
additional module		<input type="radio"/> courtyard lamp/control lamp <input type="radio"/> status display 1 <input type="radio"/> status display 2		
lights/Lamps page 25		prewarning OPEN	<input type="radio"/> OFF, 1...30s <input checked="" type="radio"/> = OFF	
	prewarning CLOSE	<input type="radio"/> OFF, 1...30s <input checked="" type="radio"/> = OFF		
	courtyard lamp <sup>1)</sup>	<input type="radio"/> OFF, 5...950s <input checked="" type="radio"/> = OFF		
	control lamp <sup>1)</sup>	<input type="radio"/> illuminates when opening/closing <input type="radio"/> blinks slowly / illuminates / blinks <input type="radio"/> illuminates in open position		
diagnosis page 26	status display	status display of all inputs		
	delete positions	<input type="radio"/> NO <input type="radio"/> YES		
	factory setting	<input type="radio"/> NO <input type="radio"/> YES		
	software version	show software version		
	Serial number	show serial number		
	protocol	show protocol notes		
	status sensor	show sensor		

ESC

ENTER



## Warning

- Before taking off the control cover, the mains switch must be turned off!
- If the control is power supplied, its inner part is under tension.
- In order to avoid electrical strokes, the safety regulations have to be kept.
- The device may only be connected by trained professionals.



- The product is not suitable for installation in explosion-hazardous areas.
- An all-pole disconnecting mains switch with a contact opening gap of min. 3 mm has to be foreseen. The gate facility has to be secured according to the valid safety regulations!
- **IMPORTANT:** The control lines (sensor, buttons, radio, photocells, etc.) have to be laid **separately from the 230V lines** (supply line, motors, signal lamp).



The different menu points are indicated as follows:

○ = selectable setting    ⊙ = factory settings    ⇌ = status display

📁 shows the menu points which are in the "BASIC SETTINGS"

- A general status display of all inputs can be found in the menu DIAGNOSIS / STATUS DISPLAY

## Buttons / switches

## Connections and adjustments

## Impulse button (terminals X1: 30/32)

## Buttons/switches

- ⊙ **OPEN/ STOP / CLOSE impulse repetition:** After a command of the impulse switch the motor starts an open or close movement. If the impulse switch is pressed again during this movement, the motor stops. With the next command, the motor drives in the opposite direction of the last gate movement.
- **OPEN / CLOSE / OPEN impulse repetition:** After a command of the impulse switch the motor starts an open or close movement. If the impulse switch is pressed again during this movement, the motor reverses.



- In this operation mode it is not possible to stop the motor with the impulse switch – it always travels until reaching an end position. (Opened or closed position).
- for the function OPEN/CLOSE/OPEN we strongly suggest the installation of a photocell!

- **OPEN:** Only open commands are accepted of the impulse switch. Closing the gate with the impulse switch is not possible.
- **DEAD-MAN:** The motor opens as long as the impulse switch is pressed – closing the gate with the impulse switch is not possible. As soon as the switch is released, the gate stops. If hold to run operating mode is selected, **the radio receiver slot (FE) is set out of order for reasons of safety.**



**IMPORTANT: Do not put into operation in dead man mode.**  
Select only after putting into operation (📁 page 28), if desired.



As impulse emitters pushbuttons or key switches as well as external radio receivers (deactivated in DEAD-MAN mode) with potential free make contacts can be used.

## Pedestrian function (terminals X1: 30/34)

## Buttons/switches

- ⊙ **Partial opening:** The contact at terminals X1: 30/34 will be used as pedestrian button.
- **Impulse OPEN:** The contact at terminals X1: 30/34 works as a second impulse button with the fixed adjustment „OPEN“.

## Pedestrian button (terminals X1: 30/34)

Buttons / switches



By selecting the setting „emergency mode = active“ the pedestrian function is inactive.  
The emergency mode stays activated by using the **closed contacts of the PEDESTRIAN-button!**

- **OPEN/ STOP / CLOSE impulse repetition:** During the gate movement an impulse of the pedestrian button leads to stop the movement. The next impulse, when the gate is within the pedestrian area, leads to move the gate in the opposite direction, when the gate is outside the pedestrian area, the gate moves to the final open position of the pedestrian function.
- **OPEN / CLOSE / OPEN impulse repetition:** An impulse of the pedestrian button, when the gate is within the pedestrian area, leads to move the gate in the opposite direction, when the gate is outside the pedestrian area, the gate moves to the final open position of the pedestrian function.



• In this operation mode it is not possible to stop the motor with the pedestrian button – it always travels until reaching an end position. (Opened or closed position).  
• for the function OPEN/CLOSE/OPEN we strongly suggest the installation of a photocell!

- **OPEN:** Only open commands are accepted of the pedestrian opening button. Closing the pedestrian entry with the button is not possible.
- **DEADMAN:** The motor opens as long as the pedestrian button is pressed – closing the gate with the pedestrian button is not possible. As soon as the switch is released, the gate stops. If hold to run operating mode is selected, **the radio receiver slot (FE) is set out of order for reasons of safety.**



The **DEAD MAN** setting cannot be actively selected, but it gets automatically selected when the impulse button is set on **DEAD MAN**.



As pedestrian button you can use pushbuttons or key switches as well as external radio receivers with potential free make contacts can be used.

## CLOSE-button (terminals X1: 30/33)

Buttons / switches

- A command with the CLOSE-switch engages closing of gate. In deadman mode the gate closes as long as the CLOSE-switch is pressed/switched. As soon as switch is released the gate movement stops.



As CLOSE-buttons you may use pushbuttons or key switches as well as external radio receivers with potential free make contacts can be used.

## STOP-button (terminals X1: 30/31)

Buttons / switches

- when pressing the stop button the gate stops in any desired position.



As stop button a break contact has to be used.  
If no stop button is connected, terminals X1: 30/31 have to be wire-bridged.

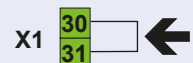

The stop input has no emergency stop function! - In order to ensure the emergency stop function, provide the supply line with an all-pole disconnecting emergency stop switch, that locks after actuation!

## Emergency mode

Buttons / switches

- **not active**
- **active:** The gate can be opened in DEADMAN mode with reduced speed by the IMPULSE-button or closed with the CLOSE-button in case of malfunction or failure of the safety devices. The emergency mode can be activated by closing the pedestrian button inputs and changing the settings to „emergency mode = active“. During the emergency mode the pedestrian function is unusable.  
In order to deactivate the emergency mode the settings need to be changed to „emergency mode = not active“ and the PEDESTRIAN-button contacts need to be opened again.

## Illumination 10s (terminals X1: 10/11)

Buttons / switches

- **not active**
- **active:** Output Illumination (terminals X1:10/11) active: e.g. for illuminating the door for the duration of the movement plus 10 seconds.



### Important: Photocells notes

- The control unit has a power supply connection for a 24V a.c. photocell (PHC):  
supply PHC-transmitter: terminals X1: 41/42 / supply PHC-receiver: terminals X1: 43/44  
Note: in „gate closed“ position the terminals X1: 41/42 are being switched into energy saving mode (no current) (only, if no TX 310 system is used) !
- The contact has to be closed when using powered and positioned photocells (opening contact).  
Connection of the photocell contact: terminals 45/46, photocell back area contact: terminals 45/48

- When using two pairs of photocells please do not install both photocell transmitters/receivers on the same side (to eliminate interference between both) !

Standard:

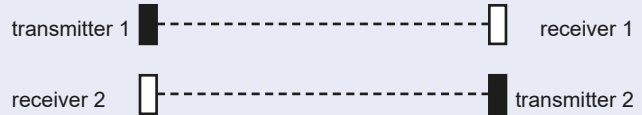

Exception: photocells with SYNC function allow the installation of both photocell transmitters/receivers on the same side without causing interference to each other.

With SYNC-function:



- **Photocell self-test function:** The control unit has a monitoring function for the connected photocells. A test is triggered by each impulse and will be checked if the receiver of the photocell responds to the signal from the photocell transmitter. If there is no communication between the photocell receiver and transmitter the control unit responds with an error.  
➔ The deactivation of the self-test function is only allowed if the safety installations correspond to the category 3 !
- The exact function of the photocells depend on the programming of the control unit.  
Photocell function please see menu point SAFETY / photocell function or photocell with pause time
- you will find detailed information in the corresponding photocell manual.

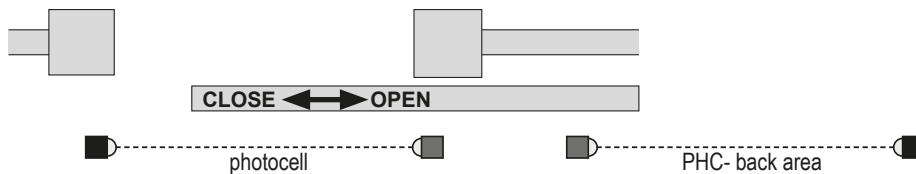

#### ☑ Photocell (contact: terminals X1: 45/46)

Safety

- ☉ **active:** to be selected, if photocell should be triggered.
- ☉ **not active:** to be selected, if photocell should not be triggered.

#### ☑ PHC-back area (contact: terminals X1: 45/48)

Safety

- ☉ **not active:** No monitoring by PHC-back area.
- ☉ **active:** To be selected, if the back area of the gate has to be protected by a photocell during the opening movement. An interruption of the photocell during the opening movement causes the motor to get stopped and remain stopped as long as the photocell is interrupted. After releasing the photocell, the gate opens.

#### ☑ PHC-function (only photocell at terminals X1: 45/46 is concerned)

Safety

- ☉ **when closing reverse:** an interruption of the photocell during closing makes the gate reverse (open). In automatic mode the gate closes as soon as the pause time has run out. In impulse operation another closing command has to be given.
- ☉ **stop, after release open:** an interruption of the photocell beam during opening or closing makes the motor stop as long as the photocell stays interrupted. After release of the photocell, the gate opens. In automatic mode the gate closes as soon as the pause time has run out, in impulse operation another closing command has to be given.
- ☉ **during closing stop, then close:** an interruption of the photocell during closing makes the motor stop as long as the photocell stays interrupted. After release of the photocell, the gate closes.







### PHC-pause time (only photocell at terminals X1: 45/46 is concerned)

Safety

- **no influence of photocell:** the photocell doesn't have any influence on the pause time in automatic mode.
- **abort pause time:** in automatic mode an interruption of the photocell during pause time shortens the pause time. After release of the photocell the gate starts closing.
- **re-start pause time:** in automatic mode an interruption of the photocell during pause time, restarts the pause time. As soon as the pause time has run out, the gate closes.
- **immediate close after opening:** If the photocell is interrupted during the opening movement or in position open, the gate starts closing as soon as it reached end position open after release of the photocell.

### PHC-self test

Safety

- **active:** photocell self-test is executed with an opening impulse (switch, button) in gate position „closed“.
- **not active:** photocell self-test is not executed.



### Attention

- The photocell self-test can only be deactivated by selecting „not active“.
- The deactivation of the self-test function is only permitted if the safety installations correspond to the category 3 !

### Photocell - connection examples

#### Back area photocell Tousek LS 45/2 as safety device

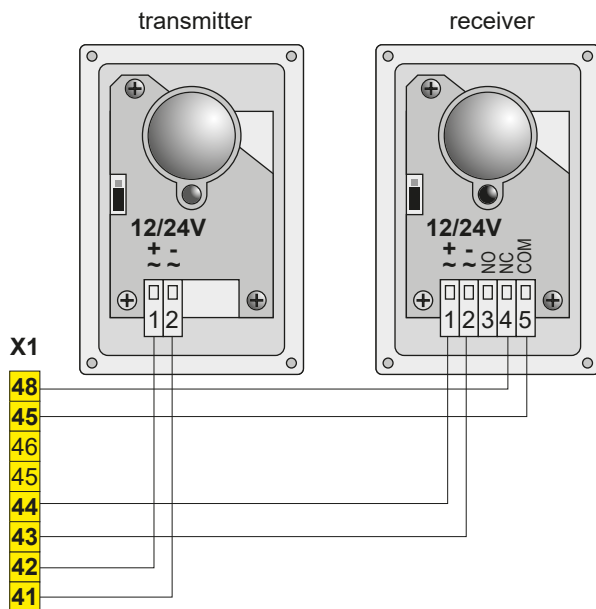

#### 2 Photocells Tousek LS 45/2 as safety device

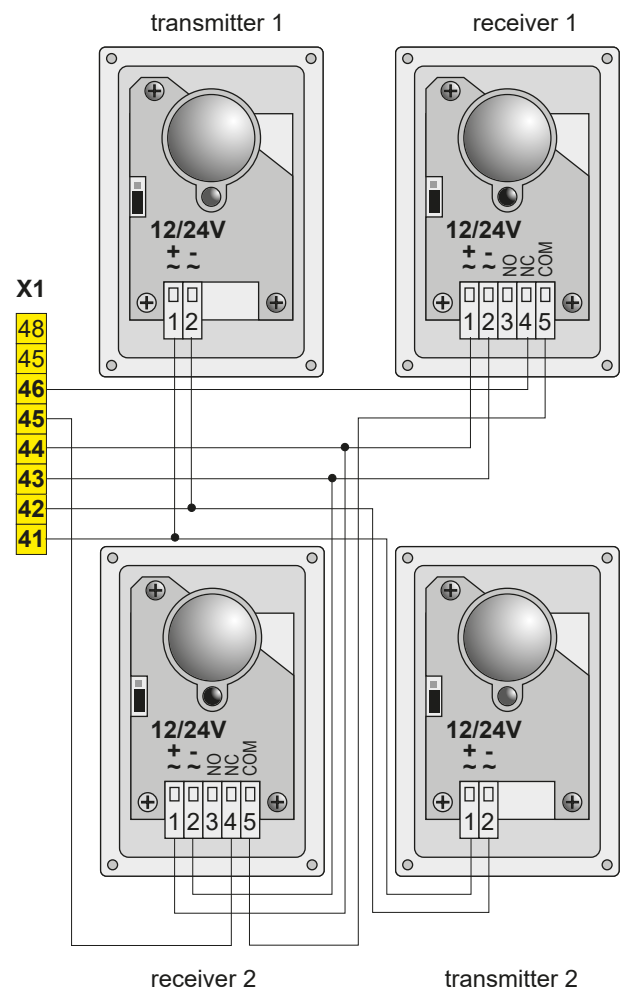

### Important

- as the LS 45/2 has no SYNC-function, both photocell transmitters and receivers must be mounted on different sides!

2 photocells Tousek LS 41 / LS 180 as safety device

2 photocells Tousek LS 41 / LS 180 as safety device with SYNC-function activated

If the SYNC-function is inactive, the photocell transmitters and receivers have to be mounted on different sides!

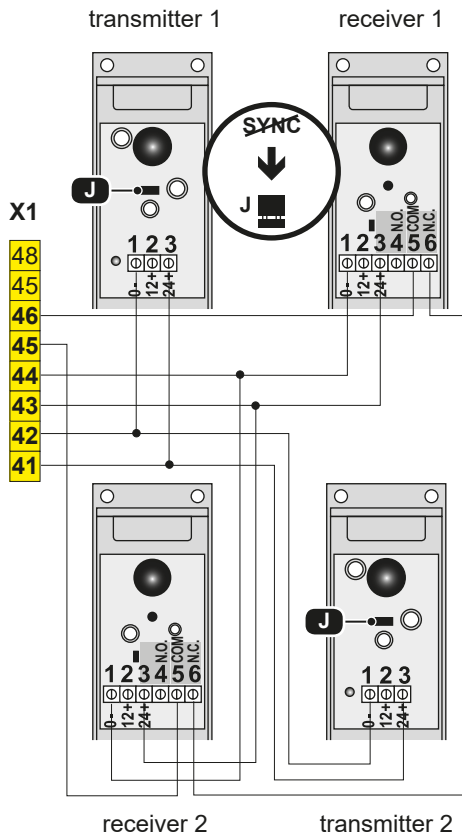

To activate the SYNC-function you have to remove Jumper J in both photocell transmitters!

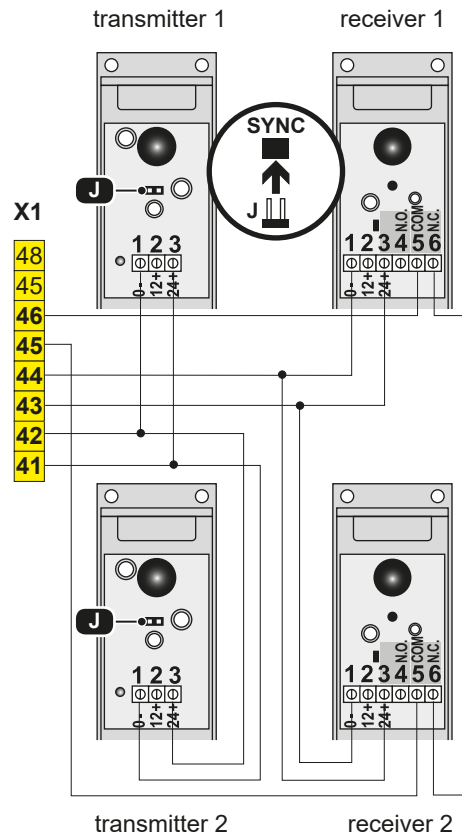

Safety edges

Connections and adjustments



Safety sensing edges (main and side edges)

• OBSTACLE DETECTION:

When a contact strip is triggered/activated then a change of direction is effected for 1 second. After that the gate stops.

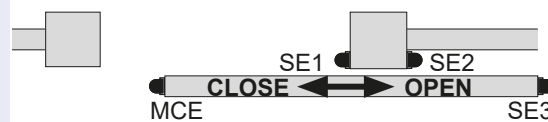

Main safety sensing edge MCE: Safety during closing

Side safety sensing edges: Safety during opening: SE1, SE3 Safety during closing: SE2

If more safety sensitive edges are required, as shown in the figure above, (e.g. second guide column), these have to be connected in series to the respective terminals SE1 and SE2.

Example: W 8,2kΩ final resistance  
 1 final edge  
 2+3 passage edge  
 S to control board

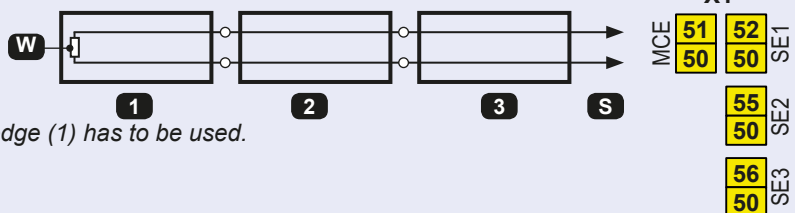

When connecting one safety edge a final edge (1) has to be used.



Important

- After giving the impulse to automatically program the end positions, no other impulse must be given. Also the safety devices mustn't be triggered. This would lead to an interruption of the programming process.
- Therefore, the mechanical stops must be set so that the existing contact strips cannot be triggered.

name in menu	short name / status display	active in direction	terminals	choice
Main clos. edge	MCE	CLOSE	50/51	<input type="radio"/> active <input type="radio"/> not active <input type="radio"/> radio edge TX <input type="radio"/> TX 400
Side edge 1 OPEN	SE1	OPEN	50/52	<input checked="" type="radio"/> active <input type="radio"/> not active
Side edge 2 CLOSE	SE2	CLOSE	50/55	<input type="radio"/> active <input checked="" type="radio"/> not active
Side edge 3 OPEN	SE3	OPEN	50/56	<input type="radio"/> active <input checked="" type="radio"/> not active <input type="radio"/> radio edge TX <input type="radio"/> TX 400

### Main closing edge (terminals X1: 50/51)

Safety edges

- active:** to be selected if the contact strip (8,2kOhm) of main closing edge should be evaluated.
- not active:** to be selected if the contact strip (8,2kOhm) of main closing edge should NOT be evaluated
- radio edge:** to be selected if the contact strip (8,2kOhm) of main closing edge should be evaluated **with the radio transmission system TX 310.**
- TX 400:** to be selected if if the contact strip (8,2kOhm) of main closing edge should be evaluated **with the system TX 400i.**

### Side edge 1 OPEN (terminals X1: 50/52)

Safety edges

- active:** to be selected if the contact strip (8,2kOhm) of side edge 1 OPEN should be evaluated.
- not active:** to be selected if the contact strip (8,2kOhm) of side edge 1 OPEN should NOT be evaluated.

### Side edge 2 CLOSE (terminals X1: 50/55)

Safety edges

- active:** to be selected if the contact strip (8,2kOhm) of side edge 2 CLOSE should be evaluated.
- not active:** to be selected if the contact strip (8,2kOhm) of side edge 2 CLOSE should NOT be evaluated.

### Side edge 3 OPEN (terminals X1: 50/56)

Safety edges





- active:** to be selected if the contact strip (8,2kOhm) of side edge 3 OPEN should be evaluated.
- not active:** to be selected if the contact strip (8,2kOhm) of side edge 3 OPEN should NOT be evaluated
- radio edge:** to be selected if the contact strip (8,2kOhm) of side edge 3 OPEN should be evaluated **with the radio transmission system TX 310.**
- TX 400:** to be selected if the contact strip (8,2kOhm) of side edge 3 OPEN should be evaluated **with the system TX 400i**

### SE-status display

Safety edges

-  Status display of safety sensing edges
 

<b>MCE</b> main closing edge	<b>SE2</b> side edge 2 CLOSE
<b>SE1</b> side edge 1 OPEN	<b>SE3</b> side edge 3 OPEN

-  status: not triggered
-  status: triggered
-  status: contact strip not connected or defect
-  status: contact strip deactivated in menu

e.g.

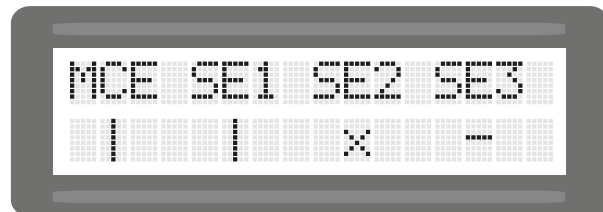

## Radio transmission system TX 310

- Connection and detailed information of radio transmission system TX 310 see according manual.



## Inductive system TX 400i

- Connection and detailed information of inductive system TX 400i see according manual.

**Speed OPEN** ☉ 100% (factory setting)

Motor

- 50–100% adjustable [increment 5]: determines the motor speed in OPENING direction.

**Speed CLOSE** ☉ 100% (factory setting)

Motor

- 50–100% adjustable [increment 5]: determines the speed of motor in CLOSING direction.

**Soft speed** ☉ 50% (factory setting)

Motor

- 25–90% adjustable [increment 5]: Determines the speed during soft run. If the soft speed is set to a value which is higher than the normal speed, that value is rejected and automatically set to 5% below the normal running speed.

**Soft path OPEN** ☉ 50cm (factory setting)

Motor

- 0–200cm adjustable [increment 10]: determines the distance of soft run in OPENING direction.

**Soft path CLOSE** ☉ 50cm (factory setting)

Motor

- 0–200cm adjustable [increment 10]: determines the distance of soft run in CLOSING direction.

**Soft stop**

Motor

- ☉ active
- not active: Soft stop deactivated.

**End position OPEN** ☉ -5 (factory setting at automatic positioning)  
☉ 0 (factory setting at manual positioning)

Motor

- +30...0...-30 adjustable [increment 1]: for readjustment of the automatically detected OPEN limit position of gate (e.g. for safety sensing barriers). With adjustment 0 the motor runs to the previously learned open position. For a diminished drive distance the value can be extended to up to -30.

This adjustment is ONLY adopted in CLOSED-position.

Deleting the end positions by selecting „diagnosis / delete positions“ effects the reset of this setting.

**End position CLOSE** ☉ -5 (factory setting at automatic positioning)  
☉ 0 (factory setting at manual positioning)

Motor

- +30...0...-30 adjustable [increment 1]: for readjustment of the automatically detected CLOSE limit position of gate (e.g. for safety sensing barriers). With adjustment 0 the motor runs to the previously learned close position. For a diminished drive distance the value can be extended to up to -30.

This adjustment is ONLY adopted in CLOSED-position.

Deleting the end positions by selecting „diagnosis / delete positions“ effects the reset of this setting.

**Attention**

With force adjustment the valid safety regulations and standards have to be strictly followed !

**Impulse mode**

Operation mode

- ⊙ **stop (at opening) - start of pause time:** An impulse during the opening movement stops the gate and starts pause time in automatic operation. When the pause time has run out, the gate closes automatically.
- **impulse suppression when opening:** Commands received during the opening movement are suppressed, commands during closing are accepted.
- **pause time extension:** A command during pause time restarts the pause time. If this menu point is chosen, an impulse suppression during opening is active at the same time.

**Opening direction**

Operation mode

- ⊙ <<<- **left:** gate opens to the left side (seen from inside)
- ->>> **right:** gate opens to the right side (seen from inside)

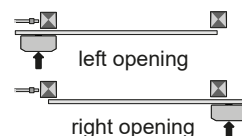

This adjustment is ONLY adopted in CLOSED-position.

**Operating mode**

Operation mode

- ⊙ **impulse mode:** Impulse through impulse switch/button or CLOSE-button to start closing of gate.
- **aut. closing, pause time 1-255s adjustable [increment 1]:** gate closes automatically after the adjusted pause time (Exception: see adjustment „Automatic mode“ / „only complete opening“).

**Partial opening** ⊙ 30% (factory setting)

Operation mode

- **10–100% adjustable [increment 1]:** value defines the partial opening based on the total opening.

This adjustment is ONLY adopted in CLOSED-position.

**Automatic mode**

Operation mode

- ⊙ **complete/partial opening:** either with complete as well as partial opening, the gate closes automatically after the adjusted pause time.
- **only complete opening:** only after complete opening, the gate closes automatically after the adjusted pause time. Exception: If the gate is in partial open position and an impulse for complete opening arrives then the gate opens completely and after the pause time it returns to partial opening position.
- **only partial opening:** only after partial opening the gate closes automatically after the the adjusted pause time.

**Pause time logic**

Operation mode

- ⊙ **no influence**
- **always open in automatic mode:** If this function is activated, the control unit changes from automatic mode into impulse mode for this cycle. Giving an impulse in gate open position effects the end of the automatic mode and the gate remains open. The next impulse changes back the impulse mode into the automatic mode and the gate closes. With this function e.g. the entrance to a company site can remain open during the day (1st impulse in gate open position) and closed in the evening (2nd impulse). The control board switches back to automatic mode (autom. opening and closing of gate).

**Note:** Pressing the pedestrian button in the open position, doesn't lead to a „remaining open“, instead the gate moves to the pedestrian opening.

If the gate is in partial open position and „permanent open in automatic mode“ is selected, so it is possible to adjust permanent partial open for this cycle by giving an impulse via **pedestrian button**. Permanent partial open can be finished analogous to the above described method.

**Additional module**

Operation mode

- ⊙ **courtyard lamp/control lamp:** the menu points courtyard lamp and control lamp are ready for adjustment (that means if not selected, these menu points will not be shown on the display)
- **status display 1:** with the two potential-free signal contacts K1 and K2, the gate end positions (limits) can be evaluated.
- **status display 2:** with the two potential-free signal contacts K1 and K2, the gate end positions (limits), the gate movement as well as a gate stop outside of the end positions can be evaluated.



**Only if an additional module (page 24) is installed you can carry out one of these adjustments (courtyard-/control lamp hence gate status 1 or 2).**

		Function	K1	K2
Gate status display	1	Gate in CLOSE-Position	1	0
		Gate in OPEN-Position	0	1
2		Gate in CLOSE-Position	0	0
		Gate opens or closes	0	1
		Gate stopped or fault	1	0
		Gate in OPEN-position	1	1

0 = signal contact open, 1= signal contact closed





## Additional module (optional) courtyard lamp/control lamp hence gate status display

- The use of one of the additional modules is optional.
- Depending on which device, e.g. a courtyard-/control lamp is chosen or evaluation of gate status should be effected, the corresponding module has to be plugged to the according slot/plug of control board.
- Additionally the corresponding value has to be selected in menu point „Additional module“

### Connecting an additional module

- turn off power supply !
- Plug additional module (Z) onto the slot (ZM).

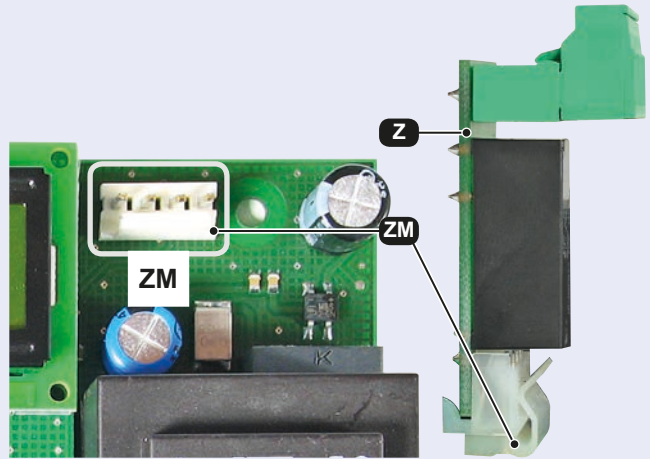

### Additional module courtyard lamp/control lamp

- On the terminals 12/13 a courtyard lamp (H) can be connected: **230V, max. 100W**
- On the terminals 70/71 a control lamp (K) can be connected: **24Vd.c., max. 2W**

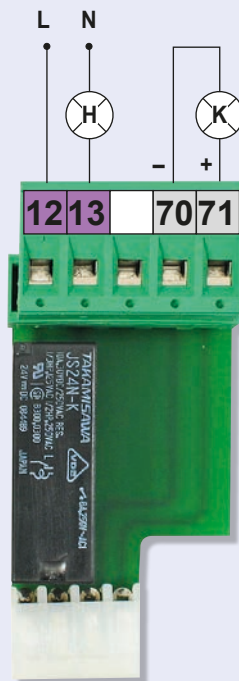

### Additional module gate status display

- with potential free signal contacts K1 (term. 90/91) and K2 (term. 92/93) the gate status can be evaluated in two ways (see menu point „Additional module“).
- Contact load: **24Va.c./d.c., max. 10W**

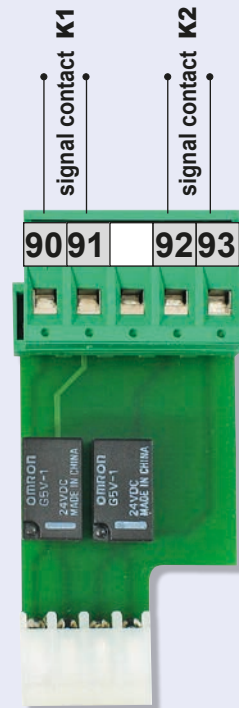



## Warning

- Before connection works please turn off the main power switch !
- Safety rules please [page 10](#) !



### Prewarning OPEN (Signal lamp:terminals X1: 10/11)

Light / Lamps

- ⊙ **switched off**
- **1–30s adjustable:** Before each opening movement the signal lamp/ flashing light is activated for the adjusted time.

### Prewarning CLOSE (Signal lamp: term. X1: 10/11)

- ⊙ **switched off**
- **1–30s adjustable:** Before each closing movement the signal lamp/ flashing light is activated for the adjusted time.



## Signal lamp

- a signal lamp can be connected to the terminals X1: 10/11 (230V, max. 40W).

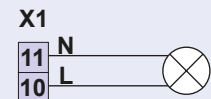

The following two menu points can only be selected if the menu point additional menu is adjusted to „courtyard-/control lamp“ (hence shown on display).

### Courtyard lamp (Description add. modules [page 24](#))

Light / Lamps

- ⊙ **switched off**
- **5–950 adjustable:** at the courtyard lamp output an external lamp can be connected (e.g. garden lamp), which can be turned on for each opening command for the duration of adjusted time.

### Control lamp (Description add. modules [page 24](#))



Light / Lamps

- ⊙ **illuminates when opening/closing:** The pilot lamp output is activated during opening- and closing movement.
- **blinks slowly / illuminates / blinks:** The pilot lamp output is activated as follows: During opening the pilot lamp flashes slowly. During pause time, in opened position or when the gate stops it is illuminated. During the closing movement it flashes rapidly. If the gate is closed, the pilot lamp expires
- **illuminates in open position:** Pilot lamp is illuminated as soon as the gate has reached end position open.

**Status display**

Diagnosis

➔ **Status display** for inputs as photocell, stop button, impulse switch ...

- |   |   |
|---|---|
| <b>I</b> impulse button                 |  status: not triggered                 |
| <b>P</b> pedestrian button              |  status: triggered                     |
| <b>C</b> CLOSE-button                   |  status: photocell deactivated in menu |
| <b>S</b> STOP-button                    |   |
| <b>Ph</b> photocell contact             |   |
| <b>Ph-B</b> photocell contact back area |   |

for example

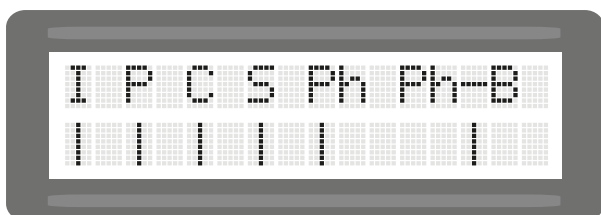

All inputs okay.



STOP button and photocell are triggered.  
All other inputs are not triggered.

➔ *Status of safety edges see page 21*

**Delete positions**

Diagnosis

- ⊙ **NO:** does not delete the end positions "gate closed" and "gate open"
- **YES:** the determined end positions are being deleted.  
Note: the end positions will be determined after new impulse.



**The mechanical stops have to be placed so that possibly existing safety contact edges can not be triggered, as this would lead to an error message.**

**Factory setting**

Diagnosis

- ⊙ **NO:** no reset back to factory settings
- **YES:** reset back to factory settings



Note: The factory settings of the single menu points are marked with ⊙ in this manual.

**Software version**

Diagnosis

➔ shows the software version on display

**Serial number**

Diagnosis

➔ shows the serial number on display

**Protocol**

Diagnosis

➔ **shows the protocol list on display:** all events that take place are protocolled in this list. with the buttons + and - the single events can be seen:

With \* the protocole beginning hence the end is shown

Time since the last event:  
DAYS HOURS : MINUTES : SECONDS

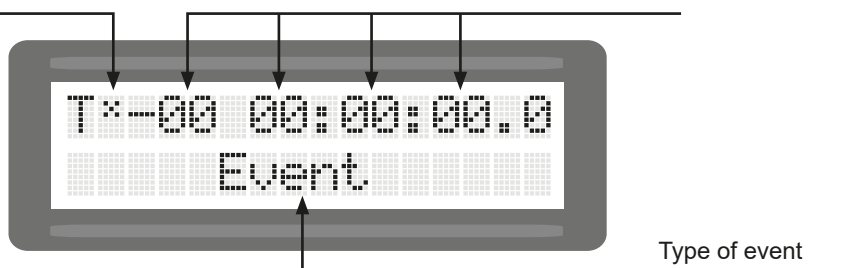

**Status Sensor**

Diagnosis

➔ Degree and sign al strenght of rotation speed sensor is shown on display.

- Turn off power supply.



- Plug-in the receiver printed circuit board (E) RS433/868-STN1 (1-channel) or RS433/868-STN2 (2-channels) into the corresponding slot (FE) as shown in the picture.
- To increase the range an external antenna FK433 or FK868 can be connected.



#### Important

- With the use of the 2-channel-receiver the second channel takes over the function of the pedestrian entry mode switch.
- For programming of receiver please *see manual for radio receiver*.

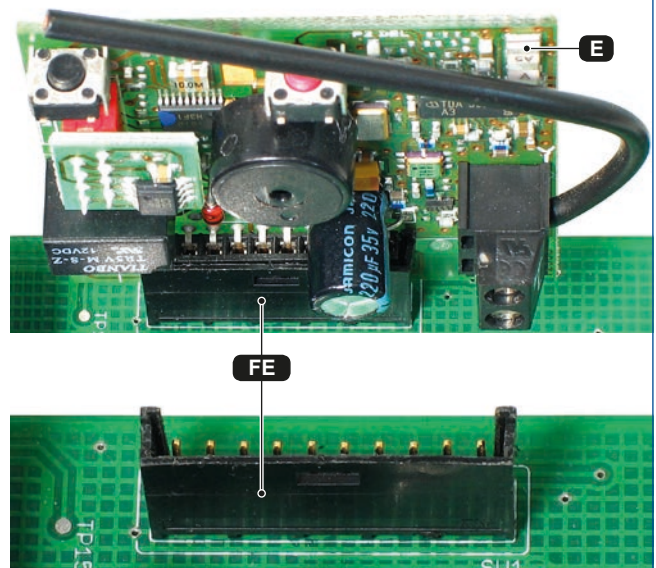
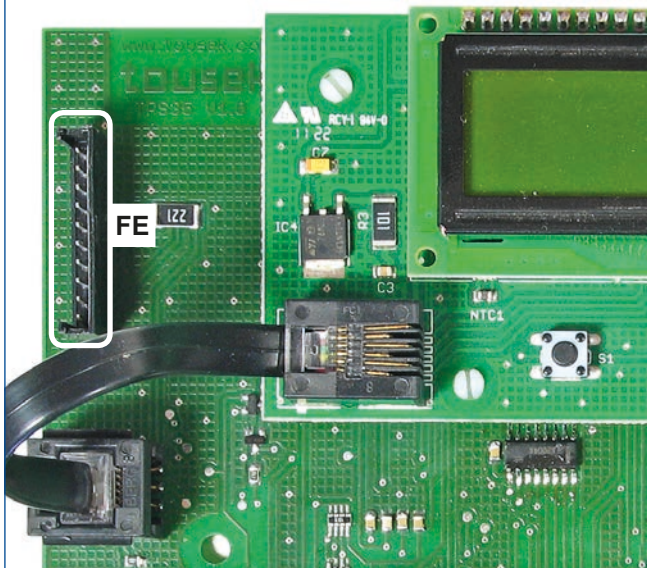

#### Important notes after installation

- Installation, connection, adjustments, putting into operation, and servicing may only be carried out by trained professionals in full accordance with these installation- and operating instructions.
- The packaging materials (cardboard, plastic, EPS foam parts and filling material etc.) have to be properly disposed of in accordance with the applying recycling and environmental protection laws. They may be hazardous to children and therefore have to be stored out of children's reach.
- The product is not suitable for installation in explosion-hazardous areas.
- The product may only be used in accordance with its original purpose, for which it has been exclusively designed, and which is described in these installation and operating instructions (especially children have to be instructed). The TOUSEK Ges.m.b.H. rejects any liability if the product is used in any way not fully conforming to its original purpose as stated herein.
- All electrical installations have to be made in full conformity with the applying rules and laws (e.g. using a fault current circuit breaker, proper grounding etc.).
- An all-pole disconnecting main switch with a contact opening-gap of minimum 3 mm has to be foreseen.
- The electric motor heats up during operation. Therefore the device should only be touched after it has cooled off.
- After installation the proper function of the gate facility and the safety devices has to be checked!
- The installer has to inform the user about all aspects of the automatic operation of the complete gate facility, as well as about emergency operation. The installer further has to supply to the user all instructions relating to the safe operation of the gate facility. The installation and operating instructions also have to be handed over to the user.



**Important: preparation works**

- All electrical installations (control panels, safety devices ...) have to be made in full conformity with the applying rules and laws. **Attention: if no stop switch is connected then the terminals 30/31 have to be bridged.**
- **The mechanical limits have to be placed so that contact edges are not triggered, as this would lead to an error message.**
- Unlock emergency release of operator and set gate to half-opened position. Then lock the operator again.
- Switch on the operator (correct connection necessary).
- **Important:** Putting into operation in Impulse mode (standard setting) and not in dead man mode.
- During initial operation the **choice of language** is made first, afterwards the choice of Gate **positioning**: „automatic“ or „manual“ and finally in the „Basic settings“ the adjustment of the most important operator settings. After the successful system test the detection of limit positions of gate is performed automatically or manually.

**Note:** If „automatic“ is selected for positioning, then with the basic setting for limit positions OPEN/CLOSE (=5), the limit stops will not be reached during operation (only with adjustment = 0).

**LANGUAGE SELECTION and POSITIONING**

- Can be selected during initial operation (hence after reset to factory settings).
- Language selection can be also chosen by pressing the ESC button (ESC) for 5s, from any position in menu..

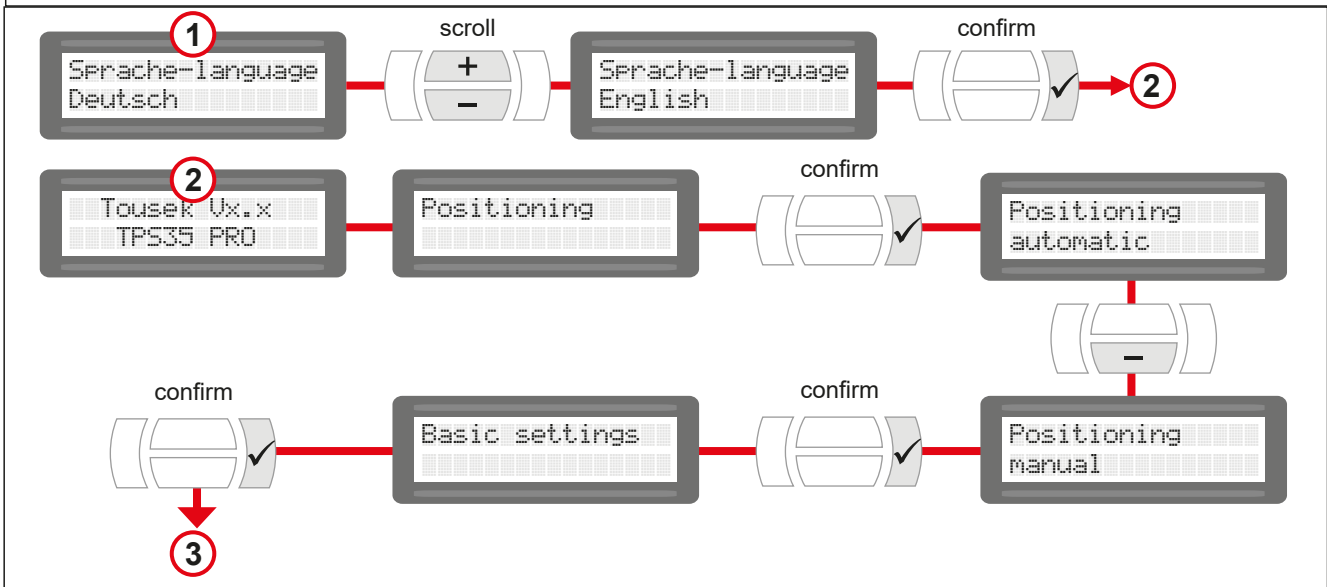

**BASIC SETTINGS**

- For setting the most important adjustments for initial operation of motor.
- Can be selected during initial operation (hence when restoring the factory setting).
- All safety devices are activated when leaving factory (see menu → 15).
- The next programming adjustments are made in the main settings menu (→ page 14, 15).

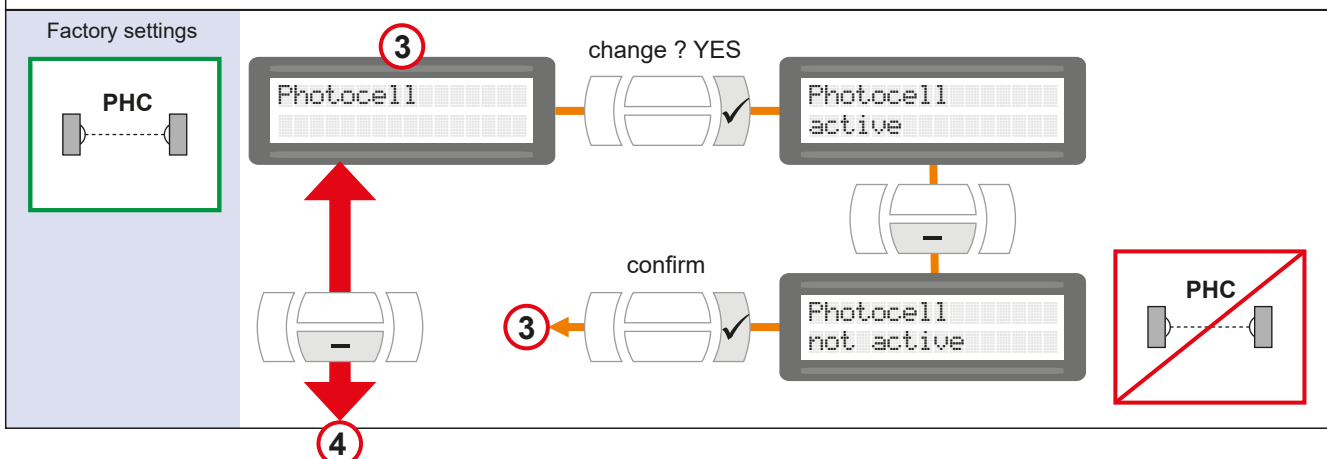



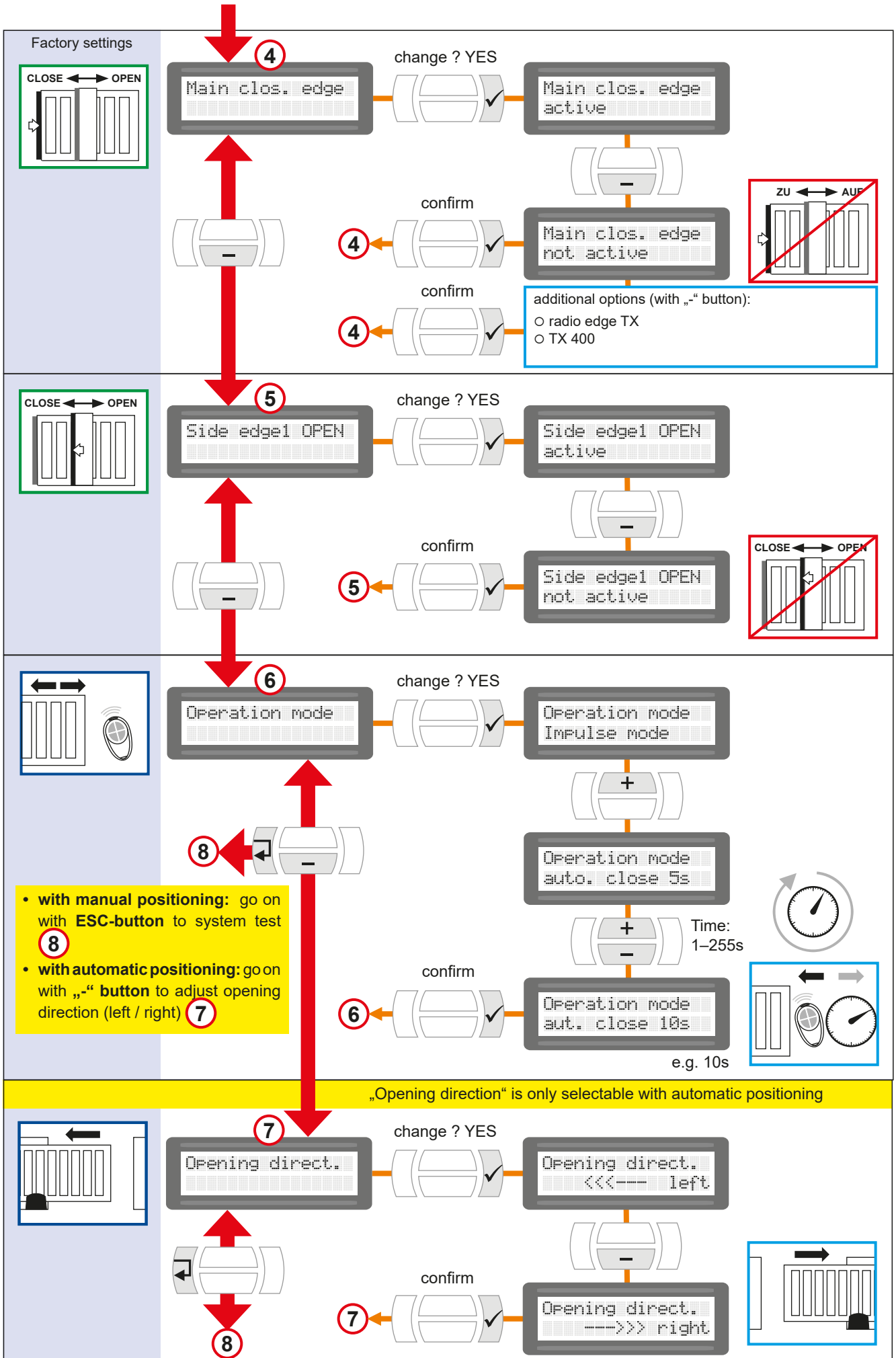

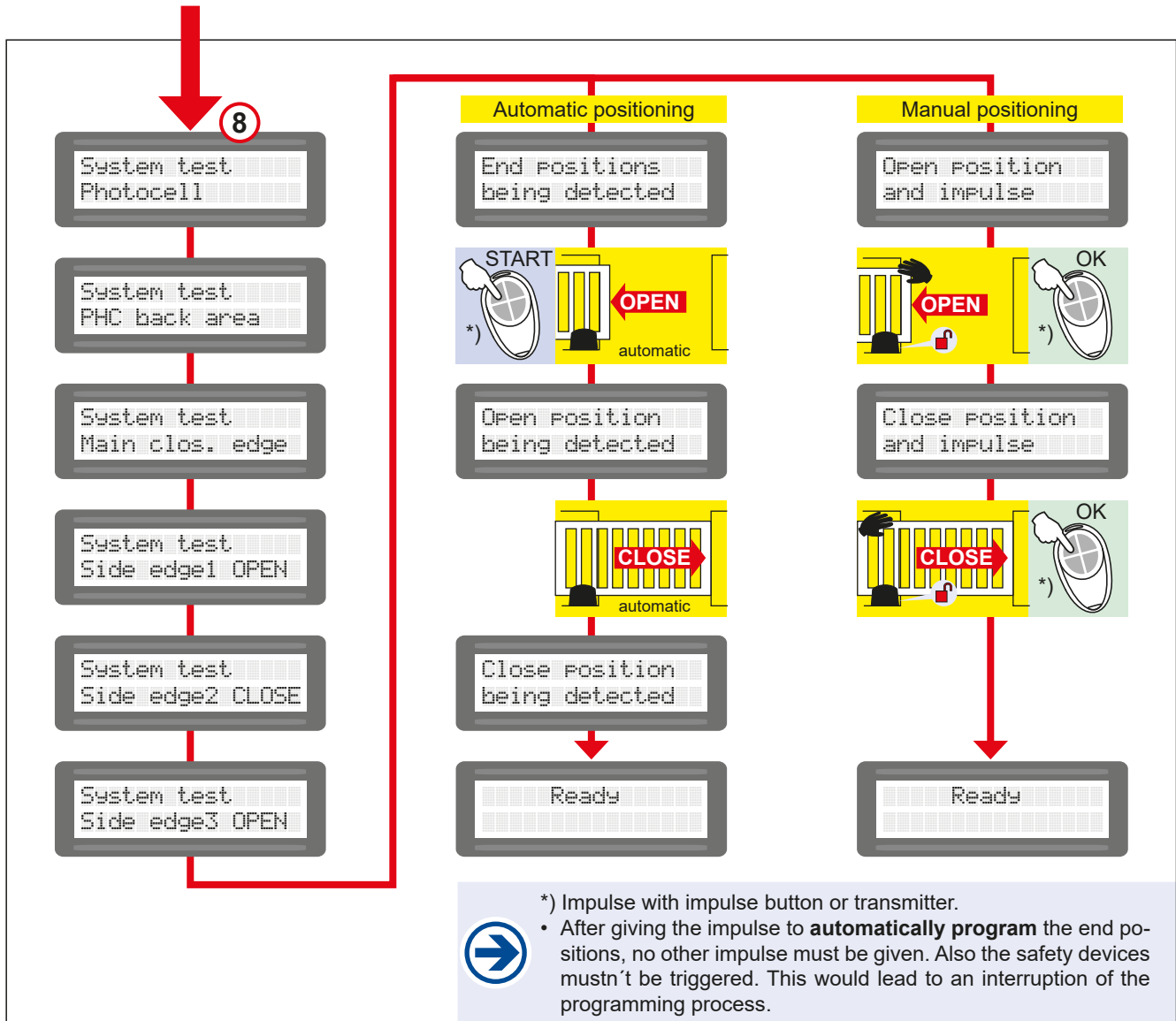

Error	possible reason	solution
Display: „Stop-button released“	stop-button not connected or not bridged	Stop-button connect or bridge > use status display for help
Display: „Photocell released“	concerned photocell interrupted	check correct connection hence remove obstacle > use status display for help
Display: „PHC-back area released“		
Display: „MCE released“	concerned safety edge interrupted or hot-wired	check correct connection hence remove obstacle > use status display for help
Display: „SE1 released“		
Display: „SE2 released“		
Display: „SE3 released“		
Display: „photocell test negative“	concerned photocell interrupted or hot-wired	check correct connection hence remove obstacle > use status display for help
Display: „PHC back area test negative“		
Display: „MCE test negative“ (only when using the TX 310)	Short-circuit or interruption of concerned safety edge	check correct connection hence battery status of transmitter > use status display for help
Display: „SE3 test negative“ (only when using the TX 310)		
No reaction when giving an impulse	no line voltage hence safety fuse broken	check line voltage as well as safety fuses
	error of transmitter/control device/impulse button, e.g. transmitter not programmed	check transmitter/control device, e.g. program transmitter and check battery
Entry to control menu not possible	Duration command is present (Impulse-, pedestrian button)	Check the commander: terminals 30/32: Impulse button terminals 30/34: pedestrian button

- 1 operator TOUSEK TPS 40 PRO with integrated control box
- 2 outer photocell (s=transmitter, e=receiver)
- 3 inner photocell (s=transmitter, e=receiver)
- 4 antenna for optional receiver
- 5 key contact switch
- 6 stop button
- 7 integrated main switch 16A (all-pole disconnecting main switch with a contact opening-gap of minimum 3 mm)

- 8 fuse 12A
- 9 safety sensing edge (o=safety when opening, s=safety when closing)
- 10 power supply system TX100 if you use a different system (e.g. TX200i or TX) see *corresponding instruction manual*
- 11 signal flashing light

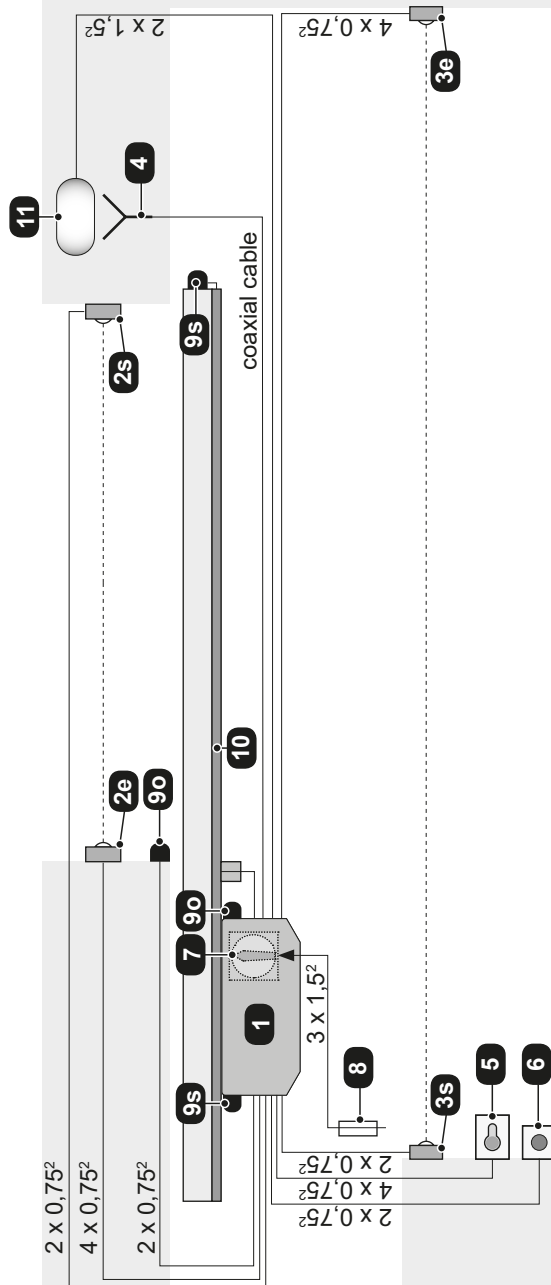

### NOTE concerning cable laying

The electric cables have to be laid in insulating sleeves which are suitable for underground usage. The insulating sleeves have to be lead into the inner of the operator housing.

230 V cables and control lines have to be laid in separate sleeves.

Only double-insulated cables, which are suitable for underground usage (e.g. E-YY-J) may be used.

In case that special regulations require another type of cable, cables according to these regulations have to be used.

### SAFETY NOTE

Please be aware that the beside picture is only a symbolic sample illustration of a gate facility and may therefore not show all safety devices required for your specific application.

To achieve an optimum safety level at your gate facility, please make sure that all safety components and accessories which - according to the applying safety rules and laws - are required in your particular case (e.g. photocells, induction loops, sensing edges, signal lamps, traffic lights, mains- and emergency power off switches etc.) are properly installed, operated, and serviced.

In this context please follow the EU Machine Directive, accident prevention rules and laws, as well as applying EU- and national standards in force at the time of installation and operation of the gate facility.

The Tousek Ges.m.b.H. cannot be held responsible for any consequences resulting from disregard of applying standards and laws during installation or operation of the gate facility.

The 0,75mm<sup>2</sup> control lines are shown without ground lead. In order to facilitate connections we recommend using flexible wires and not using thicker wires for the control lines.

- Dimensions in mm

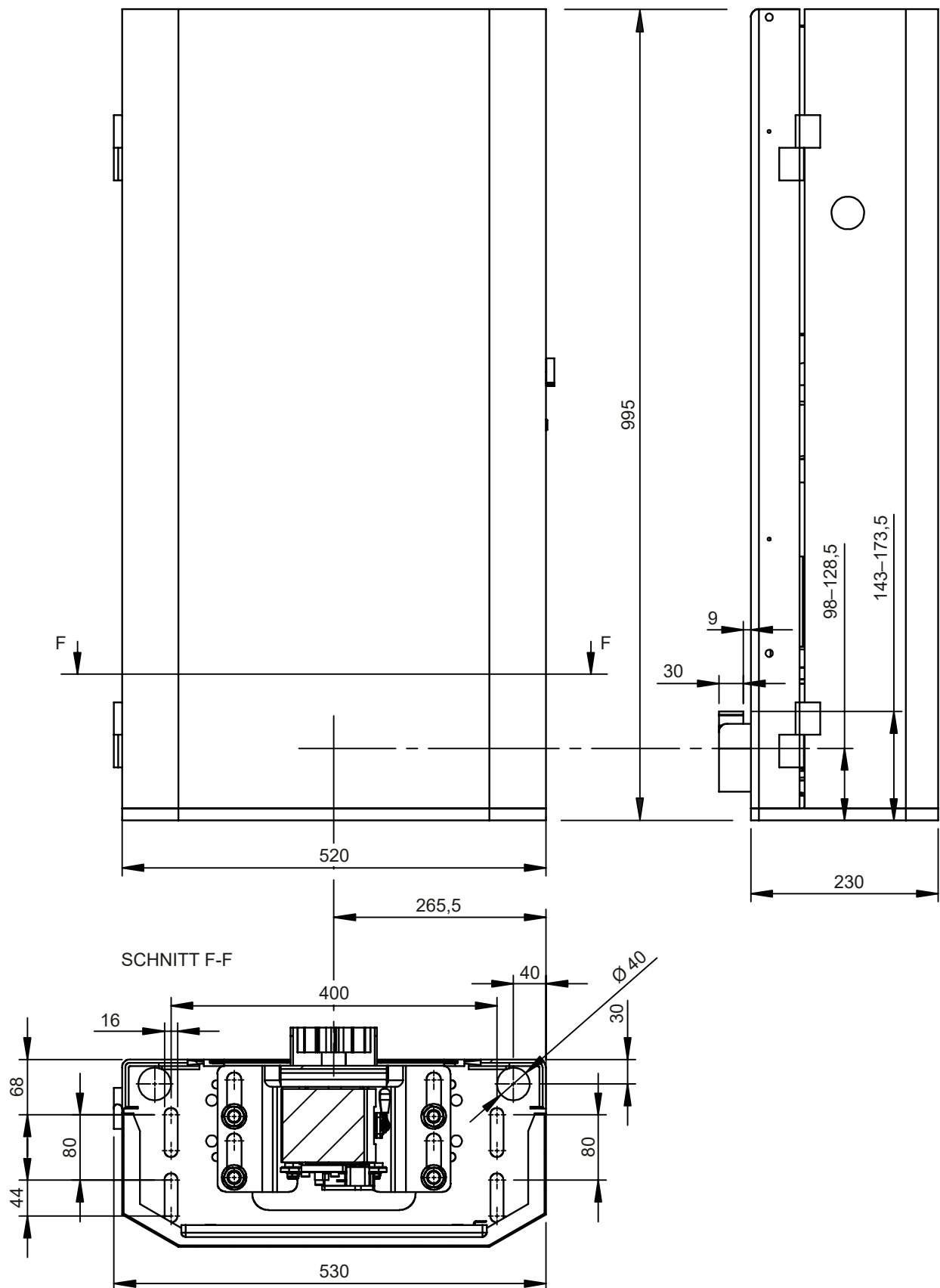

We reserve the right to change dimensions and technical specifications without prior notice!







### Declaration of incorporation

In compliance with EC Machine Directive 2006/42/EC, Annex II B for the installation of an incomplete machine.

We hereby declare that the following product, as well as its version, put by us into circulation, complies with the essential requirements of the Machinery Directive (2006/42/EC), due to its design and type of construction.

The validity of this declaration will cease in case of any unauthorized modifications to the products.

#### The product:

##### Sliding gate opener

**TPS-10, -20, -20N, -20 PRO, -20 Master/Slave, TPS 35 PRO, TPS 40 PRO, TPS 60 PRO, TPS 6speed, TPS 10speed**

is developed, designed and manufactured in accordance with:

Machinery Directive 2006/42/EG  
Low Voltage directive 2014/35/EU  
Electromagnetic compatibility 2014/30/EU

#### Applied and used standards and specifications:

EN ISO 13849-1, PL-,c“, Cat 2  
EN 60335-1 as applicable  
EN 60335-2-103  
EN 61000-6-3  
EN 61000-6-2

Following requirements of Annex I of the EC Directive 2006/42/EC are met:

1.1.2, 1.1.3, 1.1.5, 1.2.1, 1.2.2, 1.2.3, 1.2.6, 1.3.2, 1.3.4, 1.3.7, 1.5.1, 1.5.4, 1.5.6, 1.5.8, 1.7

The relevant technical documentation is compiled in accordance with Annex VII, Part B of the EC Machinery Directive 2006/42/EC.

We undertake to submit it in electronic form and within a reasonable time to the market surveillance authorities in response to a duly substantiated request.

**TOUSEK Ges.m.b.H., A1230 Wien, Zetschegasse 1, Austria**

is authorized to compile the technical documentation.

The incomplete machine cannot be put into service, until it is determined that the machine, into which the incomplete machine has to be inserted, complies with the the Machine Directive 2006/42/EC.

Eduard Tousek, CEO

Vienna, 20. 03. 2019

### EC Declaration of Conformity

In compliance with EC Machine Directive 2006/42/EC, Annex II, Part 1 A.

When the described operators are connected to a gate they form a machine in the sense of the EC Machine Directive.

#### Relevant EU directives:

Construction Products Directive 89/106/EWG  
Machinery Directive 2006/42/EG  
Low Voltage directive 2014/35/EU  
Electromagnetic compatibility 2014/30/EU

We hereby declare that the following product, in the version put by us into circulation, complies with the essential requirements of the Directives mentioned above. The validity of this declaration will cease in case of any unauthorized modifications to the products.

#### Product:

---

*Gate description*

---

*Motor description*

The incomplete machine cannot be put into service, until it is determined that the machine, into which the incomplete machine has to be inserted, complies with the the Machine Directive 2006/42/EC.

---

*Installation company*

---

*Address, ZIP code, Place*

---

*Date/ Signature*

Motor number (Type plate): \_\_\_\_\_

Other components:

## **tousek PRODUCTS**

- sliding gate operators
- cantilever systems
- swing gate operators
- garage door operators
- folding door operators
- traffic barriers
- electronic controls
- radio remote controls
- key operated switches
- access control
- safety devices
- accessories

**Tousek Ges.m.b.H. Austria**  
A-1230 Vienna  
Zetschegasse 1  
Tel. +43/ 1/ 667 36 01  
Fax +43/ 1/ 667 89 23  
info@tousek.at

**Tousek GmbH Germany**  
D-83395 Freilassing  
Traunsteiner Straße 12  
Tel. +49/ 8654/ 77 66-0  
Fax +49/ 8654/ 57 196  
info@tousek.de

**Tousek Benelux NV**  
BE-3930 Hamont - Achel  
Buitenheide 2A/ 1  
Tel. +32/ 11/ 91 61 60  
Fax +32/ 11/ 96 87 05  
info@tousek.nl

**Tousek Sp. z o.o. Poland**  
PL 43-190 Mikołów (k/Katowic)  
Gliwicka 67  
Tel. +48/ 32/ 738 53 65  
Fax +48/ 32/ 738 53 66  
info@tousek.pl

**Tousek s.r.o. Czech Republic**  
CZ-252 61 Jeneč u Prahy  
Průmyslová 499  
Tel. +420 / 777 751 730  
info@tousek.cz

**tousek**

E\_TPS-40-PRO\_03  
04. 04. 2019



**tousek**<sup>®</sup>  
G A T E A U T O M A T I O N

*your service partner:*

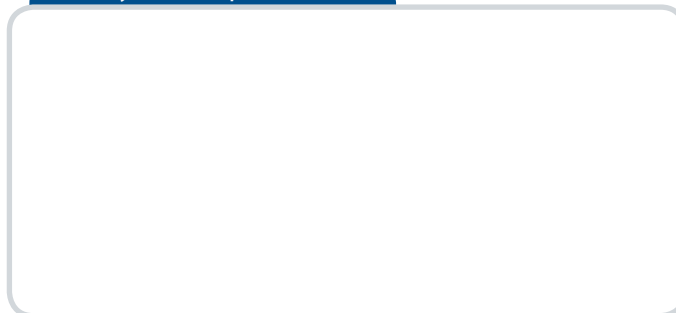

We reserve the right to change dimensions and/or technical specifications without prior notice. Claims resulting from misprints or errors cannot be accepted.

